



OpenScape WLAN Phone WL4 OpenScape WLAN Phone WL4 Plus

User Manual

A31003-M2000-U109-01-7619

Provide feedback to further optimize this document to edoku@atos.net

As reseller please address further presales related questions to the responsible presales organization at Unify or at your distributor. For specific technical inquiries you may use the support knowledgebase, raise - if a software support contract is in place - a ticket via our partner portal or contact your distributor.

Our Quality and Environmental Management Systems are implemented according to the requirements of the ISO9001 and ISO14001 standards and are certified by an external certification company.

Copyright © Unify Software and Solutions GmbH & Co. KG 29/04/2020

All rights reserved.

Reference No.: A31003-M2000-U109-01-7619

The information provided in this document contains merely general descriptions or characteristics of performance which in case of actual use do not always apply as described or which may change as a result of further development of the products. An obligation to provide the respective characteristics shall only exist if expressly agreed in the terms of contract.

Availability and technical specifications are subject to change without notice.

Unify, OpenScape, OpenStage and HiPath are registered trademarks of Unify Software and Solutions GmbH & Co. KG. All other company, brand, product and service names are trademarks or registered trademarks of their respective holders.

Contents

1 Introduction.....	7
1.1 Target Group.....	7
1.2 Prerequisites.....	7
1.3 GDPR Considerations.....	7
2 Handset Description.....	8
2.1 Handset Overview.....	8
2.2 User Interface.....	10
2.3 Display Icons and Text.....	11
2.4 Alphanumeric Keys.....	14
2.4.1 In Idle Mode and in Number Input Mode.....	15
2.4.2 In Text Input Mode.....	15
2.4.3 Hot Keys.....	15
3 Basic Operation.....	16
3.1 Switch the Handset On and Off.....	16
3.2 Turn the Signals Off or On.....	16
3.3 Lock and Unlock the Keypad.....	17
3.4 Use the Auto Phone Lock.....	17
3.5 Use the Handset as a Shared Phone.....	17
4 Calling.....	19
4.1 Call list.....	19
4.2 Incoming Calls.....	20
4.2.1 Answer the Call.....	20
4.2.2 Decline the Call.....	21
4.2.3 End the Call.....	21
4.3 Missed Calls.....	21
4.4 Outgoing Calls.....	21
4.4.1 Call Using the Numeric Keys.....	22
4.4.2 Call Using a Pre-programmed Number.....	22
4.4.3 Call Using the Local Phonebook.....	22
4.4.4 Call Using the Company Phonebook.....	22
4.4.5 Call Using the Central Phonebook.....	22
4.4.6 Call Using the Headset Button.....	23
4.4.7 User Busy.....	23
4.4.8 Call Back.....	23
4.5 During the Call.....	23
4.5.1 Adjust the Volume.....	24
4.5.2 Start a New Call.....	24
4.5.3 Switch between Two Ongoing Calls.....	24
4.5.4 Transfer the Call to a New Number.....	24
4.5.5 Transfer the First Call to the Second Call.....	25
4.5.6 Open the Contacts Menu.....	25
4.5.7 Open the Messaging Menu.....	25
4.5.8 Turn the Microphone Off or On.....	25
4.5.9 Turn the Loudspeaker On or Off.....	26
4.5.10 Call Waiting.....	26
4.5.11 Conference Call.....	26
4.6 Call Diversion.....	27
4.7 Push-to-Talk Group Call.....	28
4.7.1 Accept a PTT Invitation.....	28
4.7.2 Decline a PTT Invitation.....	29

4.7.3 Re-join a PTT Call Session.....	29
4.8 Emergency Calls.....	30
4.9 Call Services.....	30
5 Messaging.....	32
5.1 Incoming Messages.....	32
5.1.1 Message with Request for Answer.....	32
5.1.2 Message Indication Repetition.....	33
5.1.3 Message Priority.....	33
5.1.4 Call Priority.....	33
5.2 Received Messages.....	34
5.3 Sent Messages.....	34
5.4 Unsent Messages.....	34
5.5 Messaging Basics.....	35
5.5.1 Write and Send the Message.....	35
5.5.2 Reply to the Message.....	35
5.5.3 Delete the Message.....	35
5.5.4 Forward the Message.....	35
5.6 Predefined Messages.....	36
5.6.1 Answer the Message Using the Predefined Message.....	36
5.6.2 Decline the Call with a Predefined Message.....	37
5.7 Call from the Message.....	37
5.7.1 Navigate during the Call.....	38
5.7.2 Add Contact from a Message.....	38
5.8 Interactive Messaging.....	38
5.9 Colored Messaging.....	39
5.10 Voicemail.....	40
5.11 Send Data.....	40
6 Alarm Operation.....	41
6.1 Push-button and Test Alarms.....	41
6.1.1 Silent Alarm.....	42
6.2 Man-down and No-movement Alarm.....	42
6.2.1 Enable/Disable the Man-down and/or No-movement Alarm.....	42
6.2.2 Cancel Man-down and No-movement Alarm.....	43
6.2.3 Delay Man-down and No-movement Alarm Temporarily.....	43
6.2.4 Reset Man-down and/or No-movement Alarm.....	43
6.3 Automatic Call after Alarm.....	43
6.4 Emergency Call Alarm.....	44
6.5 Alarm with Additional Information.....	44
6.6 Acoustic Location Signal.....	44
7 Location Services.....	45
8 Menu Operation.....	46
8.1 Messaging.....	46
8.2 Connections.....	46
8.2.1 Bluetooth Headset.....	46
8.2.2 Wired Headset.....	47
8.2.3 Network.....	47
8.2.4 In Charger Action.....	47
8.3 Calls.....	48
8.4 Shortcuts.....	48
8.4.1 Define Keys Functions.....	49
8.5 Services.....	49
8.5.1 Add Services.....	50
8.5.2 Edit Services.....	50
8.5.3 Delete Services.....	50

8.6 Settings.....	50
8.6.1 Sound and Alert Settings.....	50
8.6.2 Automatic Keypad Lock Settings.....	52
8.6.3 Phone Lock Settings.....	52
8.6.4 Display Settings.....	53
8.6.5 Time and Date Settings.....	54
8.6.6 Answering.....	54
8.6.7 Change Text Size for Messages.....	55
8.6.8 Change the Menu Language.....	55
8.6.9 Change Owner ID.....	55
8.6.10 Alarm Settings.....	55
8.6.11 Administrator Menu.....	55
8.7 Profiles.....	56
8.7.1 User Profiles.....	56
8.7.1.1 Add New User Profile.....	56
8.7.2 System Profiles.....	57
8.8 Contacts.....	58
8.8.1 Call Contact.....	58
8.8.2 Add New Contact.....	58
8.8.3 Edit Contact.....	59
8.8.4 Set Ring Signal for a Contact.....	59
8.8.5 Delete Contact.....	59
8.8.6 Central Phonebook.....	59
9 System Handling.....	60
9.1 Device Information.....	60
9.2 Software Upgrade and Additional Features.....	60
10 Operation Notice.....	61
10.1 Accessibility and Voice Quality.....	61
11 Maintenance.....	62
11.1 Maintenance of Batteries.....	62
11.1.1 Low Battery Indication.....	62
11.1.2 Charging Methods.....	62
11.1.3 Replace the Battery.....	63
11.1.4 Energy Efficiency.....	63
12 Troubleshooting.....	65
13 Related Documents.....	68
14 Safety and Regulatory Instructions.....	69
14.1 Precautions.....	69
14.2 FCC and ISED Compliance Statements.....	69
14.3 Environmental Requirements.....	70
14.3.1 WLAN Phone.....	70
14.3.2 Battery.....	70
14.3.3 Chemical Resistance.....	70
15 Functions and Accessories.....	71
16 Menu Tree.....	73
16.1 Messaging.....	73
16.2 Connections.....	74
16.3 Calls.....	75
16.4 Shortcuts.....	76
16.5 Services.....	77
16.6 Settings.....	77

16.7 Profiles.....	80
16.8 Contacts.....	81
16.9 In Call.....	82

Introduction

The OpenScape WLAN Phone WL4 provides a wide range of features including telephony, messaging, and alarm functions. The handset is designed to be used in medium demanding environments and is aimed at users who need either one- or two-way messaging.

NOTICE: Some functions are dependent on the PBX/Call manager and protocol (SIP) versions, and your system may not support all functions described in this document. For more information, contact your system administrator or the service provider.

This document provides guidelines on how to use and maintain the following models of the WLAN handset:

- OpenScape WL4
- OpenScape WL4 Messaging
- OpenScape WL4 Plus, with messaging, location, alarm functions, and etc.

All of the handset models share the majority of the features, though some functions may differ between the handset variants. For the function list of each handset model, please refer to the [Functions and Accessories](#) on page 71.

For the technical specification, please refer to the Data Sheet, Unify OpenScape WLAN Phone WL4.

Target Group

This document is targeted at personnel responsible for handling the administration and distribution of handsets at the end customer site. It may also be of benefit to those who require in depth information about the operation and features provided by handset, such as handset users.

Prerequisites

Before using the handset, read the [Safety and Regulatory Instructions](#) on page 69.

Configuration

Before using the handset, a system administrator must register the handset in the PBX for voice functionality and in the applicable WSG modules for basic messaging services.

GDPR Considerations

The handset provides data protection by design. To comply with the GDPR by default, **Auto phone lock** and **Clear lists in charger** must be enabled in the handset. For more information, please refer to the [Use the Auto Phone Lock](#) on page 17.

Handset Description

This chapter gives an overview of the key features of the WL4 handset, including the physical design description, the use of icons and texts, as well as basic instructions for using alphanumeric keys.

This chapter includes the following sections:

- [Handset Overview](#) on page 8
- [User Interface](#) on page 10
- [Display Icons and Text](#) on page 11
- [Alphanumeric Keys](#) on page 14

Handset Overview

All handset models share the same external characteristics.

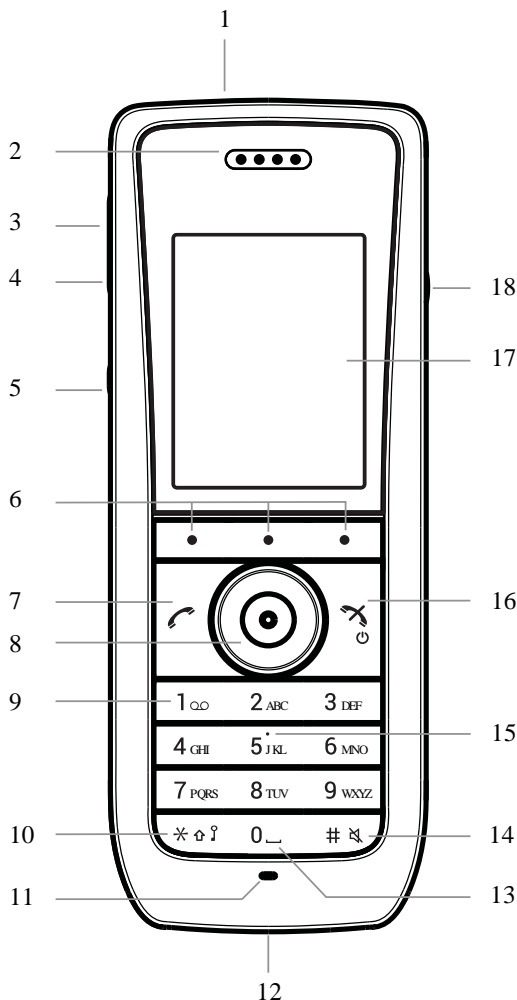

Number	External Characteristics	Description
--------	--------------------------	-------------

1	Top button	, This button can be configured for different functions. Refer to the Define Multifunction Button on page 49. In case of WL4 Plus, the button is used as a push-button alarm. Refer to the Push-button and Test Alarms on page 41.
2	Earpiece speaker	Used in voice communication.
3	Volume button (up)	Used for increasing the speaker volume.
4	Volume button (down)	Used for decreasing the speaker volume.
5	Mute button/PTT button	If used as the mute button, you can turn on/off audible signals in Idle mode, silence ring signal at incoming calls, and turn on/off the microphone during calls. If used as the PTT button, you can switch the microphone on during a PTT group call. ¹ The microphone is switched on as long as the button is pressed.
6	Soft keys	The three soft keys are located just beneath the display and the function of each soft key is indicated by text in the display just above the keys. In Idle mode, the soft keys can be used for specific functions based on their configuration. Refer to the Define Keys Functions on page 49.
7	Call key	Used for answering a call and as a shortcut to the Call list.
8	Navigation keys	Left, right, up, down and middle (confirmation) navigation keys. These keys, except for the middle key, can be configured for shortcuts. Refer to the Define Navigation Keys on page 49.
9	Voice mail access	Quick access to the handset's voice mail. ² Refer to the Voice-mail on page 40
10	Key lock Upper/lower case	Combined key lock and switch between upper and lower case text.
11	Microphone	Used in voice communication.
12	System connector	Used for battery charging, software download, and configuration.
13	Space	Used for adding space between words.

¹ Requires a WL4 Plus handset.

² System-dependent feature.

14	Sound off key	Used for turning on/off audible signals in Idle mode, silencing the ring signal at incoming calls, and turning on/off the microphone during calls.
15	Tactile indicator	Indicates the center of the keypad.
16	End key On/off key	Used for ending a call, returning to Idle mode, and by a long press for switching the handset on/off.
17	Color display	2.0-inch TFT full color display with backlighting.
18	Headset connector	3.5–mm connector used for connecting a headset. ³ It is protected against dust by using the headset connector cover.

User Interface

The interface of the handset is divided into two separate screens:

- **Idle mode** is the main screen of the handset, where you can find information about the current date, active connections as well as the name of the system to which the handset is connected to and the Owner ID. For the details, refer to the [Display Icons and Text](#) on page 11.
- **Main menu** gives you a quick access to the functions, such as Messaging, Call, Contacts, and etc.

For the whole list of functions and their use, refer to the [Menu Operation](#) on page 46.

To get the detailed information about the whole **Main menu** structure, refer to the [Menu Tree](#) on page 73.

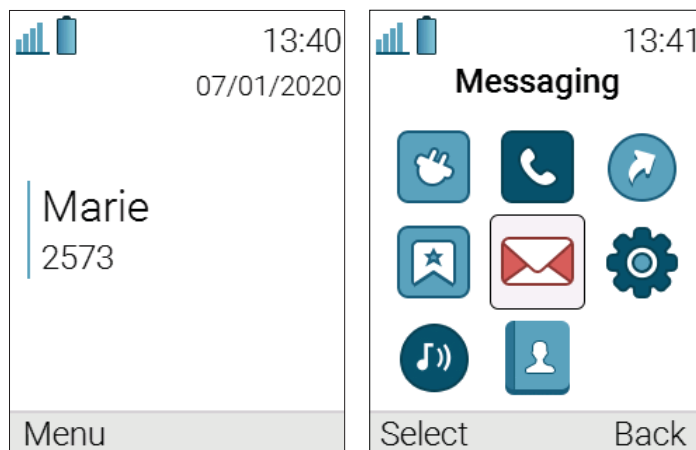









Figure 1: Idle mode (left) and the Main menu (right)

Table 1: Main menu overview

	The Messaging menu contains message handling functionality, such as reading and writing messages.
	The Connections menu contains bluetooth connection, headset selection, network selection, and in charger behavior selection.

³ Compatible with wired headsets used for Android.

	The Calls menu contains call lists and call services. Call services ⁴ is configured in the WinPDM/WSG DM.
	The Shortcuts menu contains shortcuts for the soft keys, hot keys, navigation keys, and the multifunction button.
	The menu contains pre-programmed functions.
	The Settings menu contains personal handset settings such as changing the ring volume, selecting language, etc.
	The Profiles menu allows up to four different profiles to be added .
	The Contacts menu contains all names/numbers in the contact list. In addition, a company phonebook with up to 1000 entries can be downloaded to the handset via the WinPDM/WSG DM. A central phonebook can also be accessed from the Contacts menu.

Display Icons and Text

Functions and settings available to the user are shown as icons and text on the display. This section describes the status and system icons and their functions.

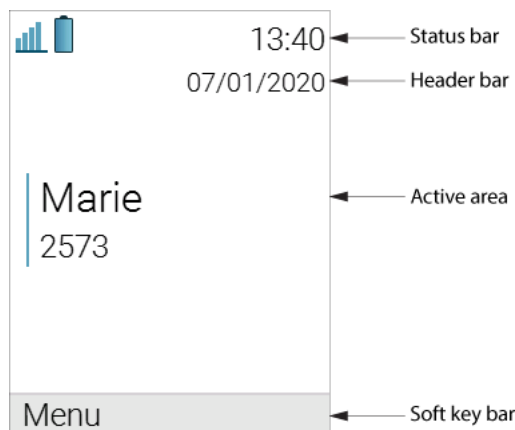

Figure 2: Example of the screen in Idle mode

Status bar shows icons that give the user information about signal strength, battery status, sound off, missed calls, new messages/voice mail, key lock, phone lock, and time. This row is always visible on all screens.

Header bar displays headset connection, Bluetooth connection/Bluetooth headset connection, man-down and no-movement functions, and the current date.

Active area is used for information such as the name of the system to which the handset is connected to. A user identity provided by the system and/or an Owner ID can also be displayed if













⁴ Access to call services is system-dependent.















configured. This is also the area for dialog window text, for example `Missed calls` or to confirm an action.

Soft key bar is used for soft keys that can be used as shortcuts for functions in the handset.

The **Scroll bar** can be found on the right of the **Active area**. It becomes visible when a menu screen has more than six menus, or if the complete text in a message cannot be displayed on the screen simultaneously.













Table 2: Status and system icons description

Icon	Name	Description
	Signal strength	Indicates the strength of the signal. The icon is located in the Status bar.
	Full battery	Indicates that battery has 75 to 100% remaining capacity. All icons indicating the battery capacity status are located in the Status bar.
	High battery level	Indicates that battery has 50 to 75% remaining capacity.
	Medium battery level	Indicates that battery has 25 to 50% remaining capacity.
	Low battery warning	Indicates that battery has 10 to 25% remaining capacity.
	Very low battery warning	Indicates that battery has 7 to 10% remaining capacity.
	Empty battery warning	The icon is flashing in the Status bar and indicating that battery has 7% or less remaining capacity.
	Incoming call	Indicates incoming calls and answered calls. The icon appears in the Call list and in a call window when the call is received.
	Missed call	Indicates missed calls. The icon is located in the Call list and in the Missed calls.
	Missed call	Indicates missed calls. The icon appears in the Status bar.
	Outgoing call	Indicates outgoing calls. The icon appears in the Call list and in a call window when making a call.
	On hold call	Indicates that this call has been placed on hold. The icon appears in a call window during the call.
	Call diverted internally	Indicates that the received call has been diverted internally. The icon appears in the Call list.

	Call diverted externally	Indicates that the received call has been diverted externally. The icon appears in the Call list.
	Call diverted internally	Indicates that the received call is diverted to another internal handset. The icon appears in the Status bar.
	Call diverted externally	Indicates that the received call is diverted to another external handset. The icon appears in the Status bar.
	Secure call	Indicates a secure voice connection. The icon appears in a call window during the call.
	Non-secure call	Indicates a non-secure voice connection. The icon appears in a call window during the call.
	New message (sent by another handset)	Indicates that a new text message (or messages) has arrived. The icon appears in the Status bar and the Inbox. NOTE: The icon stays in the Status bar until all new messages in the Inbox are read.
	New message (sent by the system)	Indicates that a new message has been sent by the system. The icon appears in the Status bar and the Inbox. NOTE: The icon stays in the Status bar until all new messages in the Inbox are read.
	Message with request for answer	Indicates that you have received a message that requires the response from you. The icon appears in the Inbox.
	Sent message	Indicates that a text message has been sent. The icon appears in the list of the Sent messages.
	Read message	Indicates that a text message has been read. The icon appears in the Inbox.
	Unsent message	Indicates that a message has not been sent. The icon appears in the list of Unsent messages.
	Voicemail message	Indicates that you have received a new voicemail message. The icon appears in the Status bar. NOTE: The icon stays in the Status bar until the voicemail has been listened to.
	Microphone off	Indicates that the microphone is silent. The icon appears in the Header bar. NOTE: During a PTT call, the microphone is inactive when the PTT button is released.
	Loudspeaker on	Indicates that the loudspeaker is turned on. The icon appears in the Soft key bar during a call.
	Loudspeaker off	Indicates that the loudspeaker is turned off. The icon appears in the Soft key bar during a call.

Handset Description

Alphanumeric Keys

	Sound off	Indicates that all the signals have been muted. The icon appears in the Status bar when the Sound off key or Mute button is pressed and hold.
	Silent volume	Indicates that all the signals have been muted. The icon appears in the Status bar when the Volume down button is pressed and hold or if the Silent mode is set on the handset using the WinPDM/WSG DM.
	Bluetooth	Indicates that Bluetooth is enabled. The icon appears in the Header bar.
	Bluetooth headset	Indicates that a Bluetooth headset is connected to the handset. The icon appears in the Header bar.
	Headset	Indicates that a corded headset is connected to the handset. The icon appears in the Header bar.
	Key lock	Indicates a locked keypad. The icon appears in the Status bar.
	Phone lock	Indicates a locked handset. The icon appears in the Status bar.
	Man-down alarm	Indicates that the Man-down alarm function is enabled. The icon appears in the Header bar.
	No-movement alarm	Indicates that the No-movement alarm function is enabled. The icon appears in the Header bar.
	Profile active	Indicates that a profile is active. The icon appears in the left lower part of the Active area. NOTE: If any error or warning message appears on the handset's display, the icon will be moved to the Header bar.
	Handset model Messaging	Indicates that the handset is a OpenScape WL4 Messaging. The icon is located in the right part of the Active area.
	Handset model Plus	Indicates that the handset is a OpenScape WL4 Plus. The icon is located in the right part of the Active area.

Alphanumeric Keys

Alphanumeric keys consist of numbers, letters and other special characters.

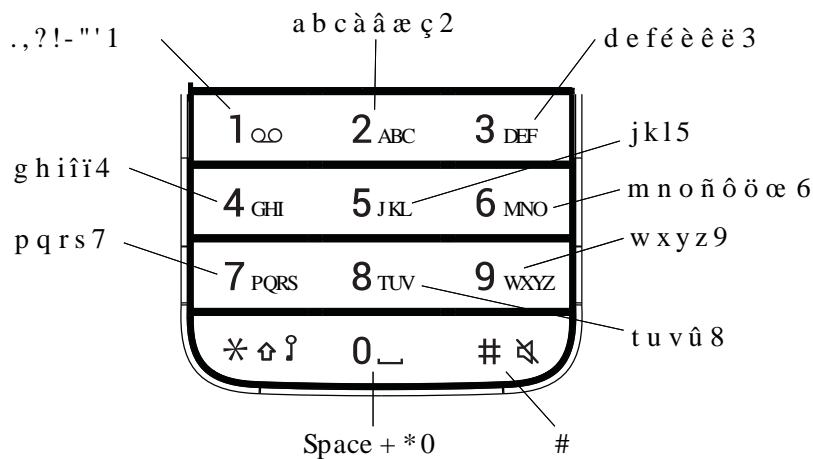

Figure 3: Available Characters

NOTICE: Depending on the selected menu language, other characters are also available. This means that the character order can differ from the figure above.

In Idle Mode and in Number Input Mode

- A short press on a key enters the digits **0–9** and the characters ***** and **#**.
- A long press on **0** enters the character **+** (used, for example, to enter an international number), if the hot key function on key **0** is disabled.
- Enter a pause in number input mode by a long press on the ***** key. A pause is indicated by a **P** in the display.

In Text Input Mode

- A short press on any of the keys **0–9** displays the first available character on that specific key. The marked character is selected after a timeout, or when another key is pressed.
- To change to upper/lower case, press the ***** key before entering the character. A short press on the ***** key can also be used to display only the digits.
- To add space in the text, short press key **0**.
- The first character entered in a message or when adding/editing a name in the Contacts menu, is an upper level character followed by lower level characters, unless the ***** key is pressed before entering the character. To switch between *Abc*, *ABC*, *abc*, and *123*, press the ***** key.
- A long press on the **#** key displays special characters.
- A long press on the ***** key changes the language used while entering a text. It is possible to enter specific characters, for example *Å*, *Ä*, or *Ö*, during a Central Phonebook search, or when writing a message if **Writing lang.** is changed.

Hot Keys

Any of the keys **0** and **2–9** can be set as a hot key. A hot key can be configured to give access to frequently used functions such as dialing a specific number, a shortcut on the menu, or sending a message. A long press on any of these numbers in idle mode is by default a shortcut to the **Call contact** list. The list is in alphabetic order, and depending on which key is pressed the list opens up at different letters of the alphabet.

Basic Operation

The following chapter describes how to use the basic functions of the WL4 handset. It is recommended to read this section when using the handset for the first time.

This chapter includes the following sections:

- [Switch the Handset On and Off](#) on page 16
- [Turn the Signals Off or On](#) on page 16
- [Lock and Unlock the Keypad](#) on page 17
- [Use the Auto Phone Lock](#) on page 17
- [Use the Handset as a Shared Phone](#) on page 17

Switch the Handset On and Off



Switch On the Handset



When switched off, press and hold the **On/Off** key  until the handset vibrates and the display lights up.

Switch Off the Handset





NOTICE: The handset can be configured to automatically switch off when placed in charger. It is also possible to configure the handset to prevent the user from switching it off. For the details, please refer to the Configuration Manual, Unify OpenScape WLAN Phone WL4.

- 1)  In Idle mode, press and hold the **On/Off** key .
- 2) The dialog window `Switch off?` is displayed. Confirm by pressing **Yes**.

Turn the Signals Off or On

NOTICE: The handset can be configured to not allow the user to mute the handset or set the volume below a certain level. For the details, please refer to the Configuration Manual, Unify OpenScape WLAN Phone WL4.

There are two different methods to turn off/on ringtones and notification sounds:



- In Idle mode, press and hold the **Sound off** key   or the **Mute** button. The **Sound off** icon  appears in the Status bar to show that the handset has been muted. Press and hold the **Sound off** key or the **Mute** button again to turn the signals on.
- In Idle mode, press the **Volume down** button. Press and hold the button again until the handset enters the silent mode. The **Silent volume** icon  appears in the Status bar to show that the handset has been muted. Press the **Volume up** button two times to unmute the handset.

NOTICE: If the second method is used and the key sound in the **Settings > Sound & Alerts > Key sound** is set to "Tone" or "Click", the keypad will not be muted.

Lock and Unlock the Keypad

To avoid that any keys are accidentally pressed, the keypad can be locked.

Lock Keypad

- 1) In Idle mode, press the **Lock** key .
- 2) Press **Lock** within two seconds. The **Key lock**  icon appears in the status bar to show that the keypad has been locked.

Unlock Keypad

- 1) In Idle mode, press the **Lock** key .
- 2) The dialog window `Unlock?` is displayed. Confirm by pressing **Yes**.

Use the Auto Phone Lock

The handset can be locked to prevent from unauthorized access. If this function is enabled, the handset will be locked automatically after certain time of inactivity or when placed in a charger⁵, and a PIN code shall be entered to unlock the handset.

Turn on/off the Auto Phone Lock

- 1) In the **Settings** menu, select **Locks > Phone lock > Auto phone lock**.
- 2) Select **On** or **On in charger** to enable the function.
Select **Off** to disable the function.
- 3) Enter PIN code (default PIN is 0000).

NOTICE: The default PIN can be changed to any 4-8-digit personalized code. If a user has forgotten the PIN code, it can be reset by the system administrator.

- 4) Press **OK**.

Use the Handset as a Shared Phone

The Shared phone feature allows more than one user to use a handset. When a handset is configured to be a shared phone, it can be used by any shared phone user in the system.

All parameters and settings that are set in the WSG DM are loaded to the handset upon login. Parameters that are changed by a user who is logged into the handset are stored by the WSG DM. When the handset is logged out or switched off, the message list and call list in the handset disappears and is empty when a new user logs in to the handset.

By default, the handset is in **Personal** mode. The handsets are configured to be shared using the WSG DM. The **Phone mode** must be set to **Shared** in the **Device > General** menu of the

⁵ Configurable feature.



WSG DM. If the user is configured as personal (that is not shared), the handset becomes a personal phone upon first login.

Log into the Handset

The handset must be switched on. For the details, refer to the [Switch the Handset On and Off](#) on page 16.

- 1) Enter the Call ID.
- 2) If required, enter the password.
- 3) Press **Login**.

Log out from the Handset

- 1)  In Idle mode, press and hold the **On/Off** key .
- 2) The dialog window `Log off?` is displayed. Press **Yes** to confirm.

At logout the owner ID is automatically removed from the Idle mode screen, but may remain in the screen saver until the screen saver is turned off.

Calling

This chapter describes how to use the call function on your WL4 handset and includes the following sections:

- [Call list](#) on page 19
- [Incoming Calls](#) on page 20
- [Missed Calls](#) on page 21
- [Outgoing Calls](#) on page 21
- [During the Call](#) on page 23
- [Call Diversion](#) on page 27
- [Push-to-Talk Group Call](#) on page 28
- [Emergency Calls](#) on page 30
- [Call Services](#) on page 30



Call list

Call list stores 25 last received, dialled or missed calls. If the call was, for example, missed more than once, the total number of occurrences is shown in brackets to the left of the number.

NOTICE: If supported by the system, the number's contact name can be displayed in the Call list.

NOTICE: The handset can also be configured to not store any calls in the Call list to ensure privacy for the users sharing the same handset. These features require configuration in the handset via WinPDM/WSG DM.

Call Using the Call list

- 1) Press the **Call** key  or go into the **Calls** menu > **Call list**.
- 2) Select the number from the list.
- 3) Press the **Call** key  or the **Call** soft key to dial.

Call list Functions

In the opened **Call list**, press **More** and select one of the following functions in the pop-up menu:

- **Time of call** to see the time and date of the call.
- **Edit number** to change the number before making a call.
- **Save number** to add the number to the list of contacts. Select **Work number**, **Mobile number**, or **Other number**.
- **Send message**⁶ to write a message to the selected number/contact in the Call list.
- **Delete** to remove the number/contact from the Call list.
- **Delete all** to remove all numbers/contacts from the Call list.

The same functions also exist in the Missed calls list, for the details refer to the [Missed Calls](#) on page 21.

⁶ Applicable to WL4 Plus only.

Incoming Calls

During the incoming call, the handset's number or the name of the caller is displayed on the screen accompanied with a ring signal and/or vibrating alert.

NOTICE: The Call ID might be hidden. This can be either done directly on the handset (refer to the [Hide Calling ID](#) on page 31) or using the WinPDM/WSG DM. For the details, please refer to the Configuration Manual, Unify OpenScape WLAN Phone WL4.

NOTICE: The ring signal and vibration can be disabled. The ring signal can be also configured to be available in both headset and loudspeaker, or only loudspeaker. For the details, please refer to the Configuration Manual, Unify OpenScape WLAN Phone WL4.

NOTICE: The name is displayed if the caller's handset number is stored in the local phonebook.

NOTICE: The handset can be configured to show the contents of the display (except for the Soft key bar) upside down at incoming calls. This feature can be configured directly on the handset (refer to the [Rotate Display Text](#) on page 53) or using the WinPDM/WSG DM. For the details, please refer to the Configuration Manual, Unify OpenScape WLAN Phone WL4.

Pickup Groups

It is possible to configure the handset in a way to allow all the users included in the pickup group list to answer other users' incoming calls when they are not available. When the call is received and the called party cannot answer the call, it is automatically forwarded to the pickup group. For the details, please refer to the Configuration Manual, OpenScape WLAN Phone WL4.

Answer the Call

There are several ways to answer an incoming call on the handset:

- When the call is received, press the **Call** key  or **Accept** to answer the call.

NOTICE: It is possible to configure the handset to answer the call with any key instead of the **Call** key as well as to change the answering behavior into **Automatically**, **Loudspeaking**, or **Quick answer**. For the details, refer to the [Answering](#) on page 54.

- When the call is received, press the **Loudspeaker off**  in the Soft key bar to answer the call in loudspeaking mode.
- When the call is received, press the headset button to answer the call⁷.

⁷ Applicable only if a headset is connected to the handset.

Decline the Call



When the call is received, press the **End call** key  to reject the call.

If the handset is configured to respond to the declined calls with a predefined message, the `Reply with a message template?` dialog window appears. For more information, please refer to the [Decline the Call with a Predefined Message](#) on page 37.

End the Call



While in a call, press the **End call** key  or the **End** soft key to finish the call. The duration of the call is shown on the display.

Missed Calls

NOTICE: The dialog window that appears for a missed call can be turned off by the system administrator. The handset can also be configured to not store any calls in the Call list to ensure privacy for the users sharing the same handset. These features require configuration in the handset via WinPDM/WSG DM.



When a missed call dialog window is shown, you can:

- Press **Yes** to view the details about the missed call.
- Press **No** to view the missed call later.

To locate the missed call on the handset, do one of the followings:

- Go into the **Calls** menu > **Missed calls**.

NOTICE: If supported by the system, the number's contact name can be displayed in the Missed calls list.

- Press the **Call** key  to open the Calls list. All missed calls are indicated by the **Missed call** icon .

In the opened Call list or Missed call list, press **More** if you want to view the time/date of the missed call, add the number to the list of contacts, send a message, and etc. For the full list of functions, please refer to the [Call list Functions](#) on page 19.

Outgoing Calls

Calls can made in different ways, for example by manually dialing the phone number, using the Call list or the phonebook and etc. The following section describes frequently used options for the OpenScape WLAN Phone WL4.

Call Using the Numeric Keys

- 1) In Idle mode, enter the number using the numeric keys.
 - If required, press **Clear** to erase the number.
 - If required, use the navigation keys left and right to step, add, or delete digits from the middle of the number.
- 2) Press the **Call** key  or the **Call** soft key to place a call. The number is shown on the display while dialling and during the call.

Call Internationally

An international number can be dialled from the handset by entering a + character followed by the country code and local number. To enter the + character, long press the **0** key until the character is shown in the display.

NOTICE: If the **0** key has been configured as a hot key, the + character cannot be entered and international numbers cannot be dialed this way. For more information, refer to [Define Hot Keys](#) on page 49.

Call Using a Pre-programmed Number



Navigation keys, hot keys, soft keys, or the multifunction button ⁸ can be programmed with a handset number, as described in [Shortcuts](#) on page 48.

To dial a pre-programmed number, press the pre-programmed key or button. The call will start automatically.

Call Using the Local Phonebook

- 1) Open the local phonebook by either pressing the navigation key down ⁹ in Idle mode or going into the **Contacts > Call contact**.
- 2) Select a contact from the list or search by a name/number using the **Search** field.
- 3) Press the **Call** key  or the **Call** soft key to make a call.

Call Using the Company Phonebook

- 1) In the **Contacts** menu, select **Call contact**.
- 2) The local and company phonebook appears in the same list but the company names are indicated by a **Locked entry** icon  in front of the name. Select a contact from the list or search by a name/number using the **Search** field.
- 3) Press the **Call** key  or the **Call** soft key to make a call.

Call Using the Central Phonebook

- 1) In the **Contacts** menu, select **Central phonebook** ¹⁰



⁸ Applicable to WL4 and WL4 Messaging only.

⁹ If the navigation key down is not configured for any other function.

¹⁰ This function is system-dependent.

2) Choose one of the following:

- **Search by name** and enter the required information.
- **Search by number** and enter the required information.
- **Last result** and select the last search result, then move to the step 5.

NOTICE: When searching for a contact, adding and editing a contact, the input language can be changed temporarily by long pressing the **Lock** key   . This can be used to temporarily access characters in a foreign language.

3) Press **Search**.

4) Select the name from the list.

5) Press the **Call** key  or the **Call** soft key to make a call.

Call Using the Headset Button

If a wired or a Bluetooth headset is used, the headset button can be used to dial the last called number or a predefined number.

This option can be used only if the headset has been configured to allow this. For the details, please refer to the Configuration Manual, Unify OpenScape WLAN Phone WL4.

User Busy

It is possible to configure up to four prioritized options to be presented to the user ¹¹ when an outgoing call is rejected because the remote party is busy. These options are presented in a form of pop-up notifications asking the user if a specific action should be performed, for example if an automatic call back should be made when the called party is free.

If you cancel the first pop-up, the next busy action in the list (If more than one busy action has been configured) will appear.

For the details, please refer to the Configuration Manual, Unify OpenScape WLAN Phone WL4.

Call Back

When a call is made to a busy handset or when the called party cannot answer, it is possible to automatically call back when the user is available again.

1) When a busy tone sounds, the `User busy. Order callback` text appears on the display.

2) Select **Yes** to call the person back automatically.

3) When the handset alerts, press the **Call** key  and the call will be automatically started.

All callback calls can be cancelled in **Calls > Call service > Callbacks > Cancel callbacks**.

During the Call

This section describes what you can do on the handset while having a call¹².

¹¹ This feature is system-dependent

¹² Some of the described functions are system-dependent.

NOTICE: It is possible to configure ten extra specific in call functions as well as configure the left/right soft key as a shortcut to a certain in call function, or hide the soft keys.



Adjust the Volume

Press the **Volume up** button to increase the volume, and the **Volume down** button to decrease the volume. The navigation key up and down can also be used to adjust the volume.

NOTICE: The handset can be configured to set a specific volume for different audio modes (Headset, Speaker, Loudspeaker) and as well as automatically store volume changes in the handset for future calls. For the details, refer to the Configuration Manual, Unify OpenScape WLAN Phone WL4.

Start a New Call

The second call can be made while in a call. The first call is automatically put on hold while the new call is active.



- 1) During the call, press **More**.
- 2) In the pop-up menu, select **New call**.
- 3) Enter the number or press the **Phonebook**  in the Soft key bar to select the contact from the list.
- 4) Press the **Call** key  or the **Call** soft key to start the second call. The first call is automatically put on hold while the new call is active.

Switch between Two Ongoing Calls

- 1) Select the on hold call using the navigation keys. The on hold call is indicated by the **On hold** call icon  .
- 2) Press **Retr.** to switch between the calls. The previously active call is automatically put on hold .

Transfer the Call to a New Number

NOTICE: This option is only visible when the **Allow blind call** parameter is defined on the handset. For more information, please refer to the Configuration Manual, Unify OpenScape WLAN Phone WL4.

- 1) During the call, press **More**.
- 2) In the pop-up menu, select **Transf. to new**.
- 3) Enter the number or press the **Phonebook**  in the Soft key bar to select the contact from the list.
- 4) Press **OK** or the **Call** key  or the **Call** soft key to transfer the call. When the new call is established, the party that initiated the transfer is disconnected.

Transfer the First Call to the Second Call

It is possible to transfer two calls to each other. The following transfer option is available when more than one call exists.

- 1) Select the call on hold using the navigation keys.
- 2) Press **More**.
- 3) In the pop-up menu, select **Transfer to [name]**. The two calls are connected. The **Transferred** confirmation appears and the handset enters Idle mode.

Open the Contacts Menu

- 1) During the call, press **More**.
- 2) In the pop-up menu, select **Contacts**.
- 3) Select one of the following:
 - **Call contact** to start a new call while in a call. Select the contact from a local or company phonebook. For the detail, please refer to the [Start a New Call](#) on page 24.
 - **Add contact** to create a new contact in the Contact list.
 - **Edit contact** to change the existing contact in the Contact list.
 - **Delete contact** to remove the contact from the Contact list.
 - **Central Phonebook** to start a new call while in a call. Select the contact from a local or central phonebook.

To get the detailed information on the Call contact, Add contact, Edit contact, Delete contact, and Central Phonebook options and features, please refer to the corresponding section in [Contacts](#) on page 58.

Open the Messaging Menu

NOTICE: Applicable to WL4 Plus only.

- 1) During the call, press **More**.
- 2) In the pop-up menu, select **Messaging**.
- 3) Select one of the following:
 - **Inbox** to open the list of the received messages. Any opened message is closed automatically.
 - **Write new message** to create a new message. A new message is automatically saved in the **Unsent** list.
 - **Unsent** to open the list of unsent messages.
 - **Sent** to open the list of sent messages.



Turn the Microphone Off or On

- 1) During the call, press **More**.
- 2) In the pop-up menu, select **Microphone off**.
- 3) Press **Select** to confirm. The **Microphone off** icon  appears to show that the microphone has been muted. The other party in the ongoing call cannot hear you.

To turn the microphone on, follow the steps above, but select **Microphone on** at the step 2.

NOTICE: The microphone can also be turned off/on by pressing and holding the **Sound off** key # .

Turn the Loudspeaker On or Off

- During the call, press the  icon in the Soft key bar to turn the loudspeaker on.
- During the call, press the  icon in the Soft key bar to turn the loudspeaker off.

Call Waiting

A second call can be received while in a call. The second call is usually indicated by a short two-beep tone and the `Incoming call` dialog window on the handset display.

To enable the call waiting feature on the handset, go into the **Calls > Call services > Call waiting > On**. If you want to disable the feature, select **Off**.

It is also possible to change the default call waiting behavior so that the next incoming call is, for example, rejected and a short two-beep tone is replaced with a louder melody. For the details on configuration, refer to the Configuration Manual, Unify OpenScape WLAN Phone WL4.

During an ongoing conversation, when a second call is received, do one of the following:

- Press **Accept** to answer the second call. The first call is automatically put on hold.
To switch between the calls, select a call using the navigation keys and press **Retr.**. For the details, please refer to the [Switch between Two Ongoing Calls](#) on page 24.
- Press **Decline** to reject the second call. The calling party hears an engaged tone and the call is logged as a missed call in the handset.

Conference Call

With a conference call, a conversation can be made with several participants simultaneously. The person initiating the conference call is the conference leader, and the other participants are members of the conference call.

Below is an example how to create a conference call for three people. A prerequisite for such a call is to have two ongoing calls.

- 1) Select a call on hold using the navigation keys and press **More**.
- 2) Press **More**.
- 3) Select **Conference**.
- 4) The conference call is created and all the participants joined the call.

Put a Conference Call Member on Hold

If required, the conference leader can put any member of the conference call on hold by pressing **Hold**. The conference leader can invite the person on hold back to the conference call by selecting **More > Conference**.

Quit the Conference Call

The conference leader can quit the conference call and let the other two parties continue the conversation by pressing **Hold** for one call and then selecting **More > Transfer to [name]**.

Call Diversion

NOTICE: This function is system-dependent.

All incoming calls can be redirected to another handset number. The diversion is made via **Calls > Call services > Divert calls**. For the details, please refer to the [Call Services](#) on page 30.

It is also possible to program a Soft key, Hot key, or Multifunction button ¹³ with a shortcut to the “Call diversion” menu. For the details, refer to the [Shortcuts](#) on page 48.

NOTICE: When the handset is out of range of the VoWiFi network and the **Call Forward locally** is used, the call diversion function is managed by the handset and call diversion does not work until the handset is within the range again.

NOTICE: **Call forward locally** must be set by the system administrator to show the **Divert calls** menu in the handset. For the details, refer to the Configuration Manual, Unify OpenScape WLAN Phone WL4.

Divert All Calls

- 1) In the Call menu, select **Call services > Divert calls**.
- 2) Choose between:
 - **Internal** to divert all incoming calls to another internal handset.
 - **External** to divert all incoming calls to another external handset.
- 3) Select **All calls > Edit**
- 4) Enter the number (maximum 24 digits) to divert to.
- 5) To save changes, choose one of the following:
 - Press **OK**. The check box is marked.
 - Press **Back**. For the *Save?* dialog window, press **Yes**. The check box is marked.

Divert Calls if No Reply

To divert incoming calls to any internal or external number in case the called party cannot answer, do the following:

- 1) In the Call menu, select **Call services > Divert calls**.
- 2) Choose between **Internal** and **External**.
- 3) Select **No reply > Edit**.
- 4) Enter the number (maximum 24 digits) to divert to.
- 5) To save changes, press **OK** or press **Back > Yes**

Divert Calls When Busy

To divert incoming calls to any internal or external number in case the called party is busy, do the following:

- 1) In the Call menu, select **Call services > Divert calls**.
- 2) Choose between **Internal** and **External**.
- 3) Select **When busy > Edit**

¹³ Applicable to WL4 and WL4 Messaging only.

- 4) Enter the number (maximum 24 digits) to divert to.
- 5) To save changes, press **OK** or press **Back > Yes**

Disable the Diversion

To disable the diversion, at step 3 described in [Divert All Calls](#) on page 27, select **All calls** and unmark the check box. Press **Back** to apply changes. The handset sends a diversion reason code to the system when establishing a call. The call is automatically disconnected after a few seconds.

Push-to-Talk Group Call

NOTICE: Applicable to WL4 Plus only.

Push-to-talk (PTT) provides instant voice connectivity to a group of persons. PTT is a one-way (half-duplex) communication. To talk, press and hold the **Mute/PTT** button¹⁴. Release the button to let another person to talk.

To participate in the conference, the group members must accept an invitation received as a text message. For the details, refer to the [Accept a PTT Invitation](#) on page 28.

If a member declines an invitation, they can re-join the group/conference later on. For the details, refer to the [Re-join a PTT Call Session](#) on page 29.

Every PTT group must be defined in the WinPDM/WSG DM to be able to use this function. For the details, refer to the Configuration Manual, Unify OpenScape WLAN Phone WL4.

INFO: If it is required to have key lock during an ongoing call, for example to avoid that any key is accidentally pressed, set the **Automatic key lock** to **On**. For the details, refer to the [Automatic Keypad Lock Settings](#) on page 52.

Accept a PTT Invitation

A PTT invitation is viewed the same way as an ordinary message. The message can contain up to 500 characters.

- 1) Press **Call** to accept the invitation and join the call. Refer to [Figure 4: PTT invitation window](#) on page 29.

NOTICE: The handset may accept the invitation automatically, start in inverted mute and loudspeaking mode, depending on the configuration of the received invitation.

- 2) The handset is connected to the PTT session. The invitation can now be deleted or closed by pressing **Delete** or **Close**, respectively. The call is not disconnected by pressing these soft keys.
- 3) Press and hold the **Mute/PTT** button to start talking. Release the button to let another person to talk.

¹⁴ Depends on configuration.

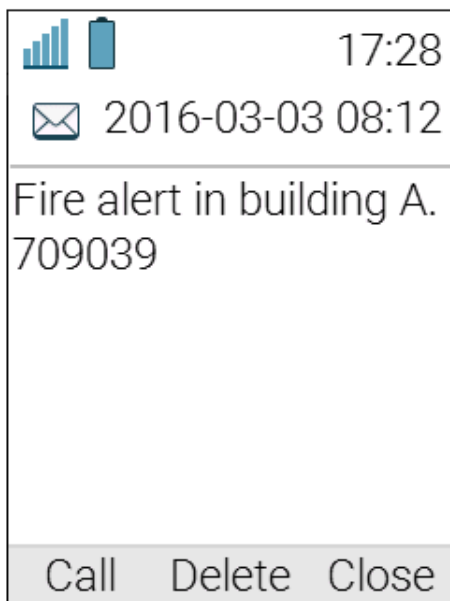

Figure 4: PTT invitation window

Invitation Received during an Ongoing Call

If a user receives a PTT invitation during an ongoing call, the call is disconnected and the PTT call is started automatically if the following conditions are true:

- The handset is configured to answer invitations automatically.
- The invitation has higher priority than the call priority.
- The user does not reject the invitation within 10 seconds.

When the invitation is received, a warning signal notifies the user before disconnecting the current call in order to connect the PTT call.

NOTICE: Depending on the priority of the invitation, the ongoing call might be disconnected immediately or after 10 seconds.

If the user rejects the invitation, it is possible to re-join the PTT later. For details, refer to the [Re-join a PTT Call Session](#) on page 29.

Decline a PTT Invitation

Most incoming PTT session invitations can be declined, if not configured to be automatically accepted.

Press **Close** to reject the invitation. The handset returns to the previously shown screen. Even if the PTT session invitation was rejected, it can be re-joined later, as long as the session remains active. For the details, refer to the [Re-join a PTT Call Session](#) on page 29.

Re-join a PTT Call Session

If a PTT session invitation was rejected or ignored, or if the session was disconnected, it is possible to re-join the call session by doing the following:

- 1) In the **Messaging** menu, select **Inbox**.
- 2) Find and open the rejected PTT session invitation (indicated by the **Message** icon ).

3) Press **Rejoin** to get back to the call session.

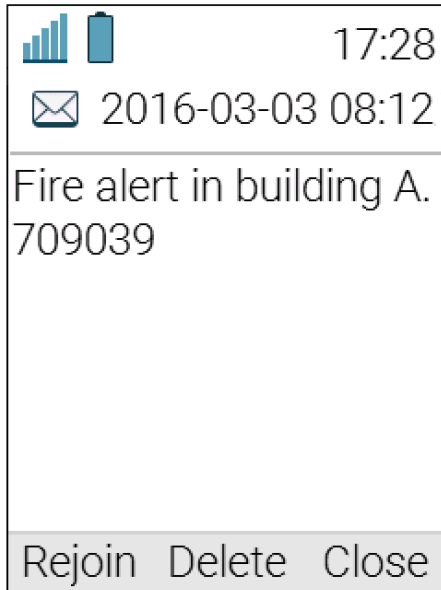

Figure 5: Re-join a PTT call session window

Emergency Calls

If configured in the WinPDM/WSG DM, up to five different phone numbers can be reserved for emergency calls. These numbers can always be called even when the phone- or key locks are active. For more information, please refer to the Configuration Manual, Unify OpenScape WLAN Phone WL4.

Emergency Ring Signal

A separate ring signal for incoming emergency callback calls can be configured in the WinPDM/WSG DM. It is used to distinguish the emergency ring signal from other handset ring signals. When an emergency call is made from the handset, it first goes to a emergency center which in turn switches the call to the appropriate emergency service. This local emergency service then calls back to the handset user, who can identify the incoming call by this specific callback emergency ring signal.

Call Services

NOTICE: The **Call services** menu provides access to PBX dependent functionality when not in call, such as absence handling and call diversion. Along with the default Call services function, 16 extra system specific call services can be defined using the WinPDM/WSG DM. It is also possible to use a Call service when the handset starts up, or when it shuts down.

Please refer to the Configuration Manual, Unify OpenScape WLAN Phone WL4, and the Installation and Operation Manual, Portable Device Manager for Windows (WinPDM).

Call Waiting

It is possible to receive a second call while in a call. To enable this feature, do the following:

- 1) In the **Calls** menu, press **Call services** > **Call waiting**.
- 2) Select **On** to activate the function.

If you want to disable the feature, select **Off** at the step 2.

Divert calls

It is possible to redirect all incoming calls to another handset number. For the details, please refer to the [Call Diversion](#) on page 27.

Do Not Disturb

- 1) In the **Calls** menu, press **Call services** > **Do not disturb**.
- 2) Select **On** to activate the function.

Select **Off** to deactivate the function.

The text `Do not disturb` remains on the idle screen as long as the function is active. Calls are rejected and indicated as missed calls. The calling party gets the message `Temporarily unavailable`.

Hide Calling ID

It is possible to hide the calling ID by doing the following:

- 1) In the **Calls** menu, press **Call services** > **Hide calling ID**.
- 2) Select **On** to activate the function.

If you want to disable the feature, select **Off** at the step 2.

This feature can be also configured using the WinPDM/WSG DM. For the details, please refer to the Configuration Manual, Unify OpenScape WLAN Phone WL4.

Messaging

NOTICE: All functions described in the current chapter are applicable to WL4 Messaging and WL4 Plus only.

This chapter describes how to use messaging function on the handset and includes the following:

- [Incoming Messages](#) on page 32
- [Received Messages](#) on page 34
- [Messaging Basics](#) on page 35
- [Predefined Messages](#) on page 36
- [Call from the Message](#) on page 37
- [Interactive Messaging](#) on page 38
- [Colored Messaging](#) on page 39
- [Voicemail](#) on page 40
- [Send Data](#) on page 40

Incoming Messages

When a text message is received, the **New message** icon  and the content of the message are automatically shown on the display. The **New message** icon remains on the display until all new messages are read. If the handset is locked with a PIN, you must first unlock the phone to read a message.

The incoming message is normally accompanied with the message alert signal and/or vibration. If you want to open and read the received message later, press **Close**. The message will be automatically stored in the **Messaging > Inbox**.

NOTICE: It is possible to configure how incoming messages are indicated and displayed on handset. For the whole list of features and instructions on how to configure them using the WinPDM/WSG DM, please refer to the Configuration Manual, Unify OpenScape WLAN Phone WL4.

Message with Request for Answer

Along with ordinary messages, you can receive messages that require the response from you.

In the Status bar, messages with request for answer are marked with the **New message** icon



. In the Inbox, such messages are marked with the **Messages with request for answer**

icon .

Accept or Reject the Message

When the message with request for answer is received, press **Accept** or **Reject**.

NOTICE: The option **Delete** is not available for a message with request for answer. To delete the message from Inbox, first you need to acknowledge the message, i.e either accept or reject it.

When a message has been acknowledged, the **Read message** icon  appears near the message in the Inbox. The **Accepted** or **Rejected** stamp as well as the time and date of acknowledgment are added to the message.

Message Indication Repetition

The handset can be configured to repeat the audio signal (alert) notifying the user about the received message. Message indication is repeated every seven seconds until the user reads the message or turns the sound off. For the appropriate message settings, please refer to the Configuration Manual, Unify OpenScape WLAN Phone WL4.

Certain system-defined properties can be assigned to a message to give it a high priority, for example, an alarm priority message. Alert repetitions start automatically when a high-priority message is received. Such messages do not need to be explicitly configured to trigger alert repeats. A high-priority alert is repeated every 10 seconds for a maximum of 5 minutes and then the alert stops.

Alerts continue to be repeated until the end key, the mute button, or a soft key is pressed to access the message.

Message Priority

This section includes a general description about message queuing and prioritizing. For the details on configuration as well as on the examples of message handling, please refer to the Configuration Manual, Unify OpenScape WLAN Phone WL4.

All incoming messages are placed in a message queue and first sorted according to the message priority and then according to the arrival time¹⁵. The handset can be configured to define how long messages keep their priority status (Time to prioritize) and if the message needs to be closed manually or automatically to move to the next one placed in the message queue (Time to Read).

Time to prioritize (TTP) starts when a message is displayed and continues to run when the message is placed in the messaging queue. Each message in the message queue is automatically displayed for the next 20 seconds, but you can extend the display time by pressing any button. If you receive a message that has higher priority than the currently displayed message, the message with lower priority is placed in queue and its TTP is paused.

Messages can be closed manually or automatically when the Time to Read (TTR) expires. Regardless of how a message is closed, it is removed from the message queue and stored in the

Inbox. The closed message is indicated by the **Read message** icon  in the Inbox.

The message that has not been closed is put last in the message queue and remains there until it has been read or closed. Such message is marked with the **New message** icon  in Inbox.

Call Priority

During incoming calls, the call information dialog is normally shown over the message. This default behavior can be changed so that messages with a certain priority are displayed without being interrupted by the calls. For the details, please refer to the Configuration Manual, Unify OpenScape WLAN Phone WL4.

¹⁵ The sorting order for the message queue depends on the system configuration.

By setting a call priority, the handset compares the call priority with the message priority to determine which information shall be displayed. If messages and calls have equal priorities, the priority will be given to the message as of higher importance.

Received Messages

All new and already read messages are stored in the **Messaging > Inbox** where they can be replied, deleted or forwarded to another party. You can also call the sender of the message or a number included in the message text, refer to the [Call from the Message](#) on page 37.

The Inbox can store up to the 30 received messages. If a message is received when the Inbox already contains 30 messages, the oldest message is automatically replaced by the new one.

Received messages normally include the number/name of the sender, time and date, but can still be configured to display another information, for example the message text. For the details, please refer to the Configuration Manual, Unify OpenScape WLAN Phone WL4.

Read the Received Message

- 1) In the **Messaging** menu, select **Inbox**.
- 2) Select the message from the list.
- 3) Press **View** to read the message.

Open the Inbox while Reading a Message

- 1) In the opened message window, press **More**.
- 2) From the pop-up menu, select **Message inbox**. The list of the received messages opens.
- 3) To go back to the previously read message, press **Back**. The message opens at the same place you left it before.

Sent Messages

All sent messages are stored in the **Messaging** menu > **Sent** where they can be forwarded or deleted from. The sent messages are forwarded and deleted the same way as the received messages. For instructions, please refer to the [Delete the Message](#) on page 35 and [Forward the Message](#) on page 35.

Unsent Messages

All messages that could not be sent, for example due to the lost Wi-Fi connection, are stored in

the **Messaging** menu > **Unsent** and indicated by the **Unsent message** icon . You can try to sent these messages again or delete them. For the details, refer to the [Delete the Message](#) on page 35.

Send the Unsent Message

- 1) In the **Messaging** menu, select **Unsent** to view the list.
- 2) Select a message and press **Edit**. Change the text if necessary.
- 3) Select **Send**.
- 4) Enter the number or press the **Phonebook**  in the Soft key bar to select the contact from the list.
- 5) When done, press **Send**. Successfully sent messages disappear from the **Unsent** list.

Messaging Basics

This section describes how to write new messages as well as how to reply to, forward, and delete the received messages.

Write and Send the Message

You can write a message from scratch or use a message template (refer to [Predefined Messages](#) on page 36) that can be edited or sent as it is. The maximum message length is normally 160 characters but may be less depending on the character set used.

To write and send a new message, do the following:

- 1) In the **Messaging** menu, select **Write new message**.
- 2) Write the message from scratch or select a message template by pressing **More**. If required, edit the message.

NOTICE: The **More** option is not displayed if no message templates have been defined.

- 3) When the message is complete, press **Send**.
- 4) Enter the number or press the **Phonebook**  in the Soft key bar to select the contact from the list.
- 5) When done, press **Send** to send the message. The `Message sent` dialog window appears to show that the message has been sent.

To open a sent message, go into the **Messaging** menu > **Sent**. Choose the message to be opened and press **View**.

Reply to the Message

- 1) In the **Messaging** menu, select **Inbox**.
- 2) Select the message you want to reply to and press **View** to open it.
- 3) Press **Reply**.
- 4) Enter the message or use the predefined message text (refer to [Answer the Message Using the Predefined Message](#) on page 36).
- 5) Press **Send**. The `Message sent` dialog window appears to show that the message has been sent.

Delete the Message

You can delete any received, unsent, and sent messages.

- 1) In the **Messaging** menu, select **Inbox** or **Unsent**, or **Sent**.
- 2) Select the message to delete.
- 3) Press **More**.
- 4) In the pop-up menu, select **Delete** or **Delete all**.
- 5) Press **Yes** to confirm. The message(s) is/are deleted.

Forward the Message

You can forward any received or sent messages.

Forward the Received Message

- 1) In the **Messaging** menu, select **Inbox**.
- 2) Select the message and press **View** to open it.
- 3) Press **More > Forward**.
- 4) If needed, write an additional text.
- 5) Press **Send**.
- 6) Enter the number or press the **Phonebook** * in the Soft key bar to select the contact from the list.
- 7) Press **Send** to forward the message.

Forward the Sent Message

- 1) In the **Messaging** menu, select **Sent**.
- 2) Select the message and press **View** to open it.
- 3) Press **Forw..**

NOTICE: You can add the number into the list of contacts before the message is forwarded, by pressing **More > Save number**. Refer to the [Add New Contact](#) on page 58.

- 4) If needed, write an additional text.
- 5) Press **Send**.
- 6) Enter the number or press the **Phonebook** * in the Soft key bar to select the contact from the list.
- 7) Press **Send** to forward the message.

Predefined Messages

Predefined messages can be used in a number of different situations, for example:

- When the same message needs to be sent out frequently as a new message, refer to the [Write and Send the Message](#) on page 35.
- When the user wants to send a fast response to the received message instead of writing an answer from scratch, refer to [Answer the Message Using the Predefined Message](#) on page 36.
- When the user wants to decline a call, but still would like to acknowledge it with a message, refer to [Decline the Call with a Predefined Message](#) on page 37.

Before a message is sent, the user may edit, add, or remove the text from the message.

Up to five predefined messages can be configured to be stored on the handset. For the details on how to create and store predefined messages, please refer to the Configuration Manual, Unify OpenScape WLAN Phone WL4.

Answer the Message Using the Predefined Message

- 1) In the opened message window, press **Reply**.
- 2) Press **More**. The **Templates** option is displayed.

NOTICE: The **More** key is not displayed if no message templates have been defined.

- 3) Press **Select**. A list of predefined message templates is displayed.
- 4) Navigate to the required message template and press **Select**. If required, edit the message.

- 5) Press **Send**. The message sender's number is displayed in the handset display.
- 6) Press **Send** again. The `Message sent` dialog window appears to show that the message has been sent.

Decline the Call with a Predefined Message

- 1) When the call is received, press the **End call** key  or the **Decline** soft key to decline the call.
- 2) In response to the `Reply with a message template?` dialog window, press **Yes**. A list of predefined messages is displayed in the **Templates** menu.
- 3) Select a message and, if required, edit it.
- 4) Press **Send**. The caller's number is shown on the handset display.
- 5) Press **Send** again. The `Message sent` confirmation appears and the message appears to show that the message has been sent.

Call from the Message

A user can make a call while reading the message to discuss it with the called party. The called party may be one of the following:

- The message sender, refer to the [Call the Sender of the Message](#) on page 37.
- A number included in the message, refer to the [Call the Number Included in the Message](#) on page 37.
- A different party, please refer to the [Call a Different Party](#) on page 37.

The user can enable the loudspeaker function during the call to make it easier to read the received text message while talking to the called party. For the details, please refer to the [Turn the Loudspeaker On or Off](#) on page 26.

Call the Sender of the Message

NOTICE: Applicable to WL4 Plus and Messaging only.

In the opened message window, press the **Call** key  or go into the **More > Call sender** and press **Select** to make a call.

Call the Number Included in the Message

NOTICE: This option is only visible if the number used in the body text message consists of minimum three digits.

- 1) In the opened message window, press **More > Call no. in text** and press **Select** open the list of numbers used in the message.
- 2) Select the number from the list and press the **Call** key  or the **Call** soft key to make a call.

Call a Different Party

- 1) In the opened message window, press **More > Call** and press **Select**.
- 2) Enter the number or press the **Phonebook**  in the Soft key bar to select the contact from the list.
- 3) Press the **Call** key  or the **Call** soft key to make a call.

Navigate during the Call

When the call has been placed from the message, the user can either get back to that message or open any other message without disconnecting from an ongoing call.

To open the message while in a call, do the following:

- 1) In the ongoing call window, press **More**.
- 2) In the pop-up menu, select **Messaging > Inbox**. The list of the received message is displayed.
- 3) Select the message from the list and press **View** to display the message in full.

If required, use navigation keys to scroll up and down a long text message while discussing it with the called party.

Add Contact from a Message

To save the sender's phone number from a message, do the following:

- 1) In the **Messaging** menu, select **Inbox**.
- 2) Select the message and press **View** to open it.
- 3) Press **More**.
- 4) In the pop-up menu, select **Save number**.
- 5) Select **Work number**, **Mobile number**, or **Other number**.
- 6) Add a name and press **OK**.
- 7) Press **Save**. The number is saved in the contact list.

Interactive Messaging

Interactive Messaging (IM) is a function that extends basic messaging, making it possible to interact with a server application in the system. An example can be machinery or equipment that can be accessed from the handset or a personnel calling application. A list of actions can be included in the message sent from the application to the handset. A typical IM received on the handset is shown below in [Figure 6: Example of an Interactive Message](#) on page 39.

An incoming IM is indicated the same way as an ordinary message and is saved along with other messages in the Inbox.

NOTICE: The indication of an IM can differ from an ordinary message depending on configuration. The application that sends the IM can determine the signal volume.

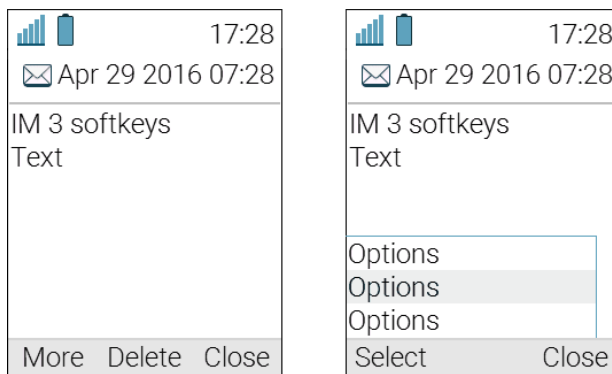

Figure 6: Example of an Interactive Message

When an IM has been read, the IM may display several options.¹⁶

Mark the one required and press **Select**. If the selected option requests input, enter the information needed and press **Ok**. A press on the * key changes to digit or text input mode depending on whether it is digit or text format in the message.

NOTICE: If a handset receives an IM update when the original message has already been deleted, the handset automatically sends a negative acknowledge to the system, if requested.

Send data function can be used to initiate the application to send the interactive message, refer to the [Send Data](#) on page 40.

Colored Messaging

Colored messaging is used to prioritize system messages by assigning different color tags to them, for example refer to the [Figure 7: Example of a Colored Message](#) on page 39. The color of a system message is shown by a color bar to the left of each message in the Inbox. High-priority alarms are automatically colored with a red color bar on the right.

NOTICE: Colored labels can be mapped to message beep codes. For more information, refer to the Installation and Operation Manual, Portable Device Manager for Windows (WinPDM).

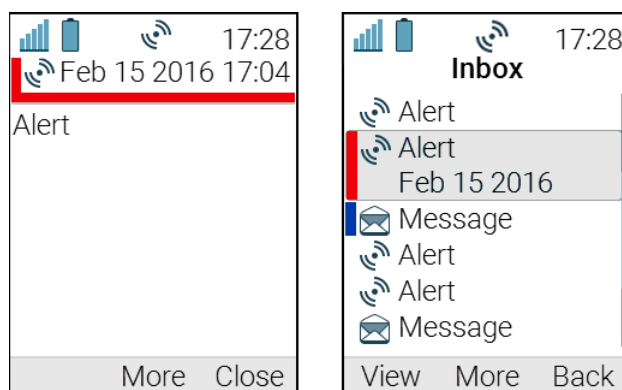

¹⁶ The options depends on the configuration in the client application.

The left image shows the color indication in the opened message window. The right image shows how system messages of different priorities look in the opened Inbox.

Figure 7: Example of a Colored Message

Voicemail

When receiving a voicemail, the voicemail notification is displayed automatically on the screen

and the **Voicemail message** icon  appears in the Status bar¹⁷.

If the **Voicemail message** icon is displayed in the Status bar, press and hold the digit key **1** in Idle mode to listen to the received voicemail message. If the extension number is not available, a dialog window `Voicemail number not defined` is displayed.

Send Data

NOTICE: Applicable to WL4 Plus only.

Data entered by the user can be sent from the handset by pressing a pre-programmed hot key or soft key, or through the **Services** menu. Such data can be used for opening a door, starting/stopping a machine, and etc. If prefix for the service user data is set, such data can be used to send information to an application in the system.

The data can be predefined when programming the soft/hot key or service, refer to the [Define Keys Functions](#) on page 49, [Define Hot Keys](#) on page 49, or [Add Services](#) on page 50.

¹⁷ Only available if configured in the system.

Alarm Operation

NOTICE: Applicable to WL4 Plus only.

Two different alarm types can be set for the handset's alarm button. An alarm can either be a **Push-button alarm** with a personal alarm functionality or a **Test alarm** that is used to test the personal alarm. The use of these alarm types is described further in this chapter.

The handset can also be programmed to send **Man-down** and **No-movement** alarms to provide personal safety monitoring. These alarms are suitable for workplaces where maximum security and accessibility is required. If an accident occur, colleagues and management are informed within seconds and the person in need can be located immediately.

The handset can also be programmed to automatically call a predefined number after the alarm has been sent, refer to the [Automatic Call after Alarm](#) on page 43.

If you use a shared phone, you must first log into the system to send and received the alarms. Refer to the [Use the Handset as a Shared Phone](#) on page 17.

NOTICE:

Recognition of alarms, warnings, and conversation messages can be hindered if the volume of these sounds used to indicate alarms, warnings, and conversation messages is lower than the surrounding sound levels.

This chapter includes the following sections:

- [Push-button and Test Alarms](#) on page 41
- [Man-down and No-movement Alarm](#) on page 42
- [Automatic Call after Alarm](#) on page 43
- [Emergency Call Alarm](#) on page 44
- [Alarm with Additional Information](#) on page 44
- [Acoustic Location Signal](#) on page 44

Push-button and Test Alarms

Two different alarm types can be set for the handset's alarm button. An alarm can either be a **Push-button alarm** with a personal alarm functionality or a **Test alarm** that is used to test the personal alarm. Each of the alarms types is enabled by the user in one of the following ways: long press and multiple press. The type of alarms and activation methods are configured by the system administrator. For the details, please refer to the Configuration Manual, Unify OpenScape WLAN Phone WL4.

Depending on configuration, either press the **Alarm button** twice (default) or use the long press to send out the alarm.

When the alarm is sent, a dialog window `Personal Alarm` (default text for multiple press) or `Test Alarm` (default text for long press) is shown on the display. The alarm is sent to the alarm center that distributes it further.

If configured in the WinPDM/WSG DM, an Acoustic Location Signal (ALS) is activated after the alarm has been sent, refer to the [Acoustic Location Signal](#) on page 44.

Silent Alarm

The silent alarm is intended for potentially hazardous environments and for situations where users do not want people nearby to know that an alarm has been triggered, in order to not escalate the situation. Silent alarms are accompanied neither by signals nor other indications, giving the possibility to send an alarm unnoticed.

If configured, the device will initiate a call giving the called party a possibility to listen in to get an understanding of a threatening situation. For the details, refer to the [Automatic Call after Alarm](#) on page 43.

Silent alarm is configured by the system administrator. For the details, please refer to the Configuration Manual, Unify OpenScape WLAN Phone WL4.

NOTICE: If both **ALS** and **Silent alarm** parameters are set for the handset, no ALS will be triggered.

Man-down and No-movement Alarm

The Man-down alarm is triggered if the handset is tilted (default 45°) from the vertical plane for a predefined period of time (default 7 s). The No-movement alarm is triggered if no movement is detected during a predefined period of time (default 30 s).

When a Man-down, or a No-movement situation has been detected, the handset enters a warning phase (usually seven seconds long). During the warning phase, the handset alerts with:

- Beep and vibrator signals (depends on the settings)
- Message `Man-down warning. Cancel?` or `No-movement warning. Cancel?`.

The handset then sends the alarm, unless the alarm is cancelled. Successfully sent alarm is indicated by and includes the following information:

- Beep or vibrator signals.
- Message `Man-down alarm sent` or `No-movement alarm sent`.
- The handset location is automatically sent along with the alarm, refer to the [Alarm with Additional Information](#) on page 44.

If configured in the WinPDM/WSG DM, an Acoustic Location Signal (ALS) is activated after the alarm has been sent, refer to the [Acoustic Location Signal](#) on page 44.

The Man-down and No-movement alarm functions are not activated under the following conditions:

- While the handset is placed in a charger.
- During calls (depending on settings), to avoid false alarms if the user tilts the handset, or is motionless during a call.
- For a predefined period of time (default 10 min) if the Mute button is pressed during the warning phase.

Enable/Disable the Man-down and/or No-movement Alarm

- 1) In the **Settings** menu, select **Alarm**.
- 2) Select **Man-down** or **No-movement**, or both. Enabled functions are indicated by the **Man-**

down  or/and **No-movement**  icons on the display.

Follow the same steps to disable the alarm.

Cancel Man-down and No-movement Alarm

A Man-down or No-movement detection can be cancelled before the alarm is sent out.

When the handset enters the warning phase and the message `Man-down warning. Cancel?` or `No-movement warning. Cancel?` appears, do one of the following to cancel the alarm:

- Press **OK**.
- Press any key including the wired headset button ¹⁸.
- Move the handset to an upright position (for Man-down). ¹⁹

Delay Man-down and No-movement Alarm Temporarily

You can delay Man-down or No-movement alarm before it is sent. To do this, during the warning phase press the **Mute** button and then press **Yes** to confirm the message `Delay MD/NM detection?`. The corresponding display icon flashes until the alarm is active again (default 10 min).

This feature can be enabled by the system administrator using the WinPDM/WSG DM. Please refer to the Configuration Manual, Unify OpenScape WLAN Phone WL4.

Reset Man-down and/or No-movement Alarm

You can reset the alarm that has been triggered, by doing one of the following:

- Move the handset to an upright position (after Man-down).
- Move the handset (after No-movement).
- Press any button ²⁰ including the wired headset button.
- Press the **Mute** button if the ALS sounds.

The corresponding icon flashes until the alarm has been reset.

Automatic Call after Alarm

A handset can be set up to call a predefined number after an alarm has been sent, for example to “112” which is the common emergency call number inside the European Union.

NOTICE: Any ongoing call will be automatically terminated prior to establishing the automatic call.

Depending on the settings, the call can be established in the following modes:

- **Loudspeaking mode** — the loudspeaker is turned on.
- **Monitor mode**
— the loudspeaker is muted and the microphone is on.
- **Normal mode**
— the call is established in an ordinary call.

¹⁸ Except for the bluetooth headset button.

¹⁹ Configured by the system administrator.

²⁰ Except for the top button.

For more information, refer to the Configuration Manual, Unify OpenScape WLAN Phone WL4.

Emergency Call Alarm

The emergency call alarm is triggered when a user calls an external or internal number specified in the system as emergency number. When an emergency call alarm is made, the default `Emergency call alarm` text is shown on the handset display.

Emergency call alarm as well as the alarm text are configured by the system administrator. For the details, please refer to the Configuration Manual, Unify OpenScape WLAN Phone WL4.

Alarm with Additional Information

Information about the approximate location of the handset is automatically sent along with an alarm. Positioning information is obtained using different location services and includes the following:

- The four latest locations from each location type (BLE).
- The two latest AP locations.

For the details on location services, please refer to the [Location Services](#) on page 45.

It is also possible to add the data, for example a number, to all type of alarms. Please refer to the [Alarm with Data](#) on page 44.

Associated Access Point (AP) Location

This function is used together with an alarm. The AP communicates to the handset where the handset is located for the time being. This gives a fair indication of the location.

An approximate location of the handset is added to alarms sent from the handset. The handset sends the current and previous AP location to indicate where the alarm was activated.

Alarm with Data

The data can be defined and stored manually by the user using the **Edit alarm data** function in the **Services** menu (refer to the [Alarm Settings](#) on page 55). The stored data is added to all types of alarms at transmission.

Acoustic Location Signal

All types of alarm can be followed by an Acoustic Location Signal (ALS). The ALS is an acoustic signal from the handset that sounds for a predefined period of time to make it possible to by ear locate the person that has initiated the alarm.

The signal is silenced by pressing the **Mute** button on the handset.

NOTICE: The ALS is not triggered if automatic call after alarm is active. However, if a call, for example an automatic call after alarm, is already established during ALS, ALS will be silenced during this call.

NOTICE: The handset can be configured to request to enter a password to turn off the ALS.

Location Services

NOTICE: Applicable to WL4 Plus only.

The handset is compatible with both Cisco Mobility Service Engine (MSE) and AiRISTA Flow Real Time Location System (RTLTS), which give a more accurate location than AP Location. The handset also supports Bluetooth Low Energy (BLE) location service.

Cisco MSE Location

APs measure the client signal strength for received data packets and forward those measurements to the Cisco MSE. Your system administrator must configure the handset for Cisco MSE. For more information, refer to the Configuration Manual, Unify OpenScape WLAN Phone WL4.

AiRISTA Flow RTLTS

The handset collects information about the APs and their measured radio field strength and forwards this information to the AiRISTA Flow Positioning Engine, which calculates the location of the handset. Your system administrator must configure the handset for AiRISTA Flow RTLTS. For more information, refer to the Configuration Manual, Unify OpenScape WLAN Phone WL4.

Bluetooth Low Energy

Bluetooth Low Energy (BLE) is a form of wireless communication designed specifically for short-range communication. The BLE technology uses BLE beacons that are strategically mounted throughout locations, to broadcast BLE signals in a given range. BLE infrastructure works indoors and outdoors.

Menu Operation

The **Main menu** gives you an access to the following functions described in the current chapter:

- [Messaging](#) on page 46
- [Connections](#) on page 46
- [Calls](#) on page 48
- [Shortcuts](#) on page 48
- [Services](#) on page 49
- [Settings](#) on page 50
- [Profiles](#) on page 56
- [Contacts](#) on page 58

Messaging

NOTICE: Applicable to WL4 Messaging and WL4 Plus only.

To open the **Messaging** menu  , do the following:

- 1) In Idle mode, press **Menu** or the middle navigation key.
- 2) Select **Messaging** and press the middle navigation key or the **Select** soft key to enter.

For information about existing messaging functions, please refer to the [Messaging](#) on page 32 chapter of this document. To get the detailed information about the whole **Messaging** menu structure, refer to the [Messaging](#) on page 73.

Connections

To open the **Connections** menu  , do the following:

- 1) In Idle mode, press **Menu** or the middle navigation key.
- 2) Select **Connections** and press **Select** or the middle navigation key to enter.

To get the detailed information about the whole **Connections** menu structure, refer to the [Connections](#) on page 74.

Bluetooth Headset

Bluetooth technology replaces the cord between the handset and the headset, which makes it possible to move more freely and eliminates the risk of a headset cord getting stuck.

The supported Bluetooth functions are the following:

- Pairing the handset with a Bluetooth headset.
- Playing ring signal in the Bluetooth headset
- .
- Answering and connecting sound to the Bluetooth headset when answering with the headset's button.
- Ending and rejecting calls with the Bluetooth headset's button.
- Dialing the last called or predefined number using the Bluetooth headset's button²¹.

²¹ Configured in the WinPDM/WSG DM.

- Transferring audio to/from the Bluetooth headset during calls using the handset menu.

NOTICE: The handset can be configured to show the dialog window asking whether the user wants to transfer the audio for the outgoing call to the headset.

- Increasing/decreasing the volume in the Bluetooth headset with the volume buttons on the handset.

To enable Bluetooth, select **Connections > Bluetooth > Enable**. When enabled, the **Bluetooth** icon  appears on the display.

To add a new device, select **Connections > Bluetooth > Headset > Add new**.

Wired Headset

To achieve optimal audio quality with the different headset types, it is recommended to select the corresponding headset profile.

To change the headset profile, perform as follows:

- 1) In the **Connections** menu, select **Headset**.
- 2) Select the corresponding headset profile from the list. Choose between **Mic on boom**, **Mic on cable**, or **Customized headset profile**.²²

NOTICE: If the preconfigured headset profiles do not match the headset in use or the audio performance is bad, a customized headset profile can be configured. Once configured, a customized profile appears in the handset menu. Please refer to the Installation and Operation Manual, Portable Device Manager for Windows (WinPDM).

- 3) Press **Select** to confirm.

Network

- 1) In the **Connections** menu, select **Network**.
- 2) Select network in the list. The handset restarts if the network is changed.

In Charger Action

This section describes different types of actions that can be configured for the handset when it is placed in a charger. Along with the options that can be selected directly from the handset menu, there are additional functions, for example **Clear Lists in Charger** or **In charger Message absent** that are configured using the WinPDM/WSG DM. For the details, refer to the Configuration Manual, Unify OpenScape WLAN Phone WL4.

Switch the Handset Off

The handset can be switched off automatically when it is placed in the charger. When it is removed from the charger, it switches on again. When the handset is switched off in the charger, the Owner ID of the handset is shown. This simplifies the identification of the handset when, for example, it is charging together with other handsets.

- 1) In the **Connections** menu, select **In charger**.
- 2) Select **Switch off**.

²² Only visible if the headset profile has been configured in the WinPDM/WSG DM.

- 3) Press **Back** to save changes.

NOTICE: If handset restrictions are enabled, the handset might not be switched off/muted when placed in the charger.

Turn the Sound Off

When the handset is placed in the charger, it will be muted. When the handset is removed from the charger, the sound switches on again.

- 1) In the **Connections** menu, select **In charger**.
- 2) Select **Switch off**.
- 3) Press **Back** to save changes.

Change Profile

The handset can change the profile automatically when it is placed in the charger²³. The profile is changed back when the handset is removed from the charger.

- 1) In the **Connections** menu, select **In charger**.
- 2) Select **Change profile**.
- 3) Press **Edit**.
- 4) Select a profile.
- 5) Press **Back** to save changes.

Disable In Charger Actions

- 1) In the **Connections** menu, select **In charger**.
- 2) Select **No action** to disable **Switch off** or **Sound off** function.
- 3) Press **Back** to save changes.

Calls

To open the **Calls** menu , do the following:

- 1) In Idle mode, press **Menu** or the middle navigation key.
- 2) Select **Calls** and press **Select** or the middle navigation key to enter.

For information on the additional call functions, please refer to the [Calling](#) on page 19 chapter of this document. To get the detailed information about the whole **Calls** menu structure, refer to the [Calls](#) on page 75.

Shortcuts

To open the **Shortcuts** menu , do the following:

- 1) In Idle mode, press **Menu** or the middle navigation key.
- 2) Select **Shortcuts** and press **Select** or the middle navigation key to enter.

To get the detailed information about the whole **Shortcuts** menu structure, refer to the [Shortcuts](#) on page 76.

²³ Applicable to WL4 Plus only.

Define Keys Functions

This section describes how to assign functions to the soft, hot, and navigation keys as well as to the multifunction button ²⁴.

Define Soft Keys

- 1) In the Shortcuts menu, select **Soft keys**.
- 2) Select **Left**, **Middle**, or **Right**.
- 3) In the opened menu, select:
 - **Name** ²⁵ to enter new or change the existing name of the soft key.
 - **Function** to choose the function for the selected soft key. The whole list of functions can be found in [Shortcuts](#) on page 76.
 - **Value** to enter a value, for example a handset number. This setting appears only to some functions.
 - **Control question** (off by default) to choose if you want the handset to ask you permission to perform an action associated with the soft key.
- 4) To save changes, choose one of the following:
 - Press **Save**. *Changes saved* dialog window appears.
 - Press **Back**. For the *Save?* dialog window, press **Yes**.

Define Hot Keys

- 1) In the Shortcuts menu, select **Hot keys**.
- 2) Select any of the keys **0** or **2–9**.
- 3) Proceed with the steps 3–4 described in the [Define Soft Keys](#) on page 49.

Define Navigation Keys

- 1) Select **Navigation keys**.
- 2) Select **Up**, **Down**, **Left**, or **Right**.
- 3) Proceed with the steps 3–4 described in the [Define Soft Keys](#) on page 49.

Define Multifunction Button

The multifunction button ²⁶ can be defined with two different functions, a long press activates one function, and a multiple press activates another function.

- 1) Select **Multifunction button**.
- 2) Select **Long press** or **Multi press**.
- 3) Proceed with the steps 3–4 described in the [Define Soft Keys](#) on page 49.

Services

NOTICE: Applicable to OpenScape WL4 Plus only.

The Services menu allows the user to create a submenu that includes up to ten frequently used functions, such as Phone call, Send data, Send message, and PTT.

²⁴ Cannot be defined for WL4.

²⁵ Name option is available only when defining the soft keys functions.

²⁶ Applicable to WL4 and WL4 Messaging only.

NOTICE: It is recommended to use services in combination with shortcuts (refer to the [Shortcuts](#) on page 48), otherwise a user needs to enter the Services menu and trigger a service from the menu.

To open the menu  , do the following:

- 1) In Idle mode, press **Menu** or the middle navigation key.
- 2) Select and press **Select** or the middle navigation key to enter.

To get the detailed information about the whole menu structure, refer to the [Services](#) on page 77.

Add Services

- 1) Select **Add new** from the **Services** menu.
- 2) Choose an appropriate name for the service and enter the name in the **Name** field.
- 3) Press **OK**. The **Function** menu is displayed.
- 4) To navigate to the required function, press up and down on the navigation key.
- 5) Press **Select** or the confirmation button on the navigation key.
- 6) If necessary, enter values in the fields (only applicable for some of the functions).
- 7) Press **Save**.

Edit Services

- 1) Mark a service by pressing up and down on the navigation key.
- 2) Press **More**.
- 3) Select **Edit**.
- 4) Edit the service parameters.
- 5) When done, press **Back** to apply changes.

Delete Services

- 1) Select a service by pressing up and down on the navigation key.
- 2) Select **More > Delete > Yes**.

Settings

To open the **Settings** menu  , do the following:

- 1) In Idle mode, press **Menu** or the middle navigation key.
- 2) Select **Settings** and press the middle navigation key or the **Select** soft key to enter.

To get the detailed information about the whole **Settings** menu structure, refer to the [Settings](#) on page 77.

Sound and Alert Settings

This section describes how to configure or change audio and vibration signals on the handset.

Adjust the Ring Volume

- 1) In the **Settings** menu, select **Sound & Alerts**.

- 2) Select **Volume**.
- 3) To increase the volume, press right navigation key. To decrease the volume, press left navigation key. Press **Back** to save the setting.

If a handset restriction is enabled, it might not be possible to set the ring volume to **Silent**. For more information, refer to the Configuration Manual, Unify OpenScape WLAN Phone WL4.

Set Different Ring Signals for Calls

- 1) In the **Settings** menu, select **Sound & Alerts > Ring signals**.
- 2) Select **Internal ring**, **External ring**, **Callback**, or **Call pickup groups**. The handset has several different ring signals.
- 3) Select a sound. To listen to the different sounds, press **Play**.

Additional ring signals can be selected if they are configured via WinPDM/WSG DM. For more information, refer to the Configuration Manual, Unify OpenScape WLAN Phone WL4.

Set Alerts for Messages

NOTICE: Applicable to WL4 Messaging and WL4 Plus only.

- 1) In the **Settings** menu, select **Sound & Alerts > Message alert**. Different message alerts can be selected.
- 2) Select a message alert from list. Press **Play** to listen to the different sounds.

INFO: The option **Custom sounds** should be selected to create a customized message alert. For more information, refer to the Configuration Manual, Unify OpenScape WLAN Phone WL4.

NOTICE: The **Play** soft key is not available for **Enhanced beep** and **Custom sound**. Instead, send a message to the handset to listen to the sound.

By default, the message volume follows the ring volume setting. However, a different message volume can be set if required. For more information, refer to the Configuration Manual, Unify OpenScape WLAN Phone WL4.

Turn the Vibrating Alert On or Off

If the vibrating alert is enabled, it vibrates on incoming calls and messages or when receiving a message during a call. For more information, refer to the Configuration Manual, Unify OpenScape WLAN Phone WL4.

- 1) In the **Settings** menu, select **Sound & Alerts > Vibrating alert**.
- 2) Select **On**, **On if silent**, or **Off**.

Set the Key Sound

- 1) In the **Settings** menu, select **Sound & Alerts > Key sound**. Choose between **Silent**, **Click**, or **Tone**.
- 2) Select key sound.

To listen to the key sound, press the **Play** Soft key.

Set the Battery Warning

When the battery is low, the warning indication can be set to different modes.

- 1) In the **Settings** menu, select **Sound & Alerts > Battery warning**.

- 2) Select **Repeated sound**, **Sound once**, or **Sound off**.

Set the Hearing Aid

- 1) In the **Settings** menu, select **Sound & Alerts > Hearing aid**.
- 2) Select **On** to enable it.

Automatic Keypad Lock Settings

NOTICE: If configured, it is possible to dial any of up to five predefined emergency numbers when the keypad is locked. Other examples of exceptions that override the key lock is personal alarm, shortcut call, mute ALS, and cancel Man-down and No movement alarms. For the details, refer to the For more information, refer to the Configuration Manual, Unify OpenScape WLAN Phone WL4.

Enable the Automatic Key Lock

- 1) In the **Settings** menu, select **Locks**.
- 2) Select **Automatic key lock**,
- 3) Choose between:
 - **On** to automatically lock the keypad if it is not used before the specified lock time expires.
 - **On, except calls** to automatically lock the keypad if it is not used before the specified lock time expires. If the user is in a call when the lock time expires, the keypad remains unlocked until the user has completed the call.
- 4) Press **Back** to re-display the **Locks** menu.
- 5) Select **Auto lock time**.
- 6) Set the lock time. The shortest time that may be specified before the keypad is automatically locked is 5 seconds and the longest time is 3 minutes.

Disable the Automatic Key Lock

- 1) In the **Settings** menu, select **Locks**.
- 2) Select **Automatic key lock > Off**.

Automatic Key Unlock

The user can configure a locked keypad to unlock automatically when a call or message is received. After the user has finished the call or message, the keypad is locked again after the specified Auto lock time expires.

- 1) In the **Settings** menu, select **Locks**.
- 2) Select **Automatic key unlock > On** to enable or **Off** to disable.

Phone Lock Settings

The handset can be protected from unauthorized access by activating the phone lock.

Enable the Phone Lock

- 1) In the **Settings** menu, select **Locks > Phone lock > Auto phone lock**.
- 2) Choose between:
 - **On** to automatically lock the handset if it is not used before the specified lock time expires.
 - **On in charger** to lock the handset immediately when placed in the charger. When removed from the charger and unlocked by the PIN, the handset remains unlocked.

- 3) Enter PIN code (default PIN is 0000).

NOTICE: The default PIN can be changed to any 4–8 digit personalized code. If a user has forgotten the PIN code, it can be reset by the system administrator.

- 4) Press **OK**.
- 5) Press **Back** twice to return to **Locks**.
- 6) Select **Auto lock time**.
- 7) Select the required lock time.

Disable the Phone Lock

- 1) In the **Settings** menu, select **Locks > Phone lock > Auto phone lock > Off**.
- 2) Enter the PIN code.
- 3) Press **OK**.

Change the PIN Code

- 1) In the **Settings** menu, select **Locks > Phone lock > Change PIN code**.
- 2) Enter the old PIN code.
- 3) Press **OK**.
- 4) Enter the new PIN code twice.
- 5) Press **Save**.

Display Settings

This section describes how to configure or change the display setting on the handset.

Brightness

- 1) In the **Settings** menu, select **Display > Brightness**.
- 2) Select **Normal** or **Power save**.
- 3) Press **Back**.

Screen Saver

The handset can be configured to display some or no information when it is not in use and when it is placed in a charger.

- 1) In the **Settings** menu, select **Display > Screen saver**.
- 2) Choose one of the following:
 - **Information** to display battery status and identification information while the handset is not in use.
 - **Black** to have a black screen when the handset is not in use.
 - **Black also in call** to have a black screen when the handset is not used during the ongoing call.
- 3) Press **Back**.

NOTICE: When the handset with the screen saver set to **Information** is in a charger, the Owner ID is displayed even if the handset switched off. This simplifies identification when many handsets are in a charging rack.

Rotate Display Text

The handset can be configured to show the contents of the display (except for the Soft key bar) upside down at incoming calls and messages. This feature can be also configured using the Win-

PDM/WSG DM. For the details, please refer to the Configuration Manual, Unify OpenScape WLAN Phone WL4.

- 1) In the **Settings** menu, select **Display > Rotate display text**.
- 2) Select **Normal** or **Inverted**.
- 3) Press **Back**.

Font Style

- 1) In the **Settings** menu, select **Display > Font style**.
- 2) Select **Normal** or **Bold**.
- 3) Press **Back**.

Time and Date Settings

Time and date format changes in the handset appear directly, but changes in the system appear after a maximum of 24 hours after a change in the system or by turning the handset off and on again.

Set Time & Date

- 1) In the **Settings** menu, select **Time & Date**.
- 2) In the opened menus, select:
 - **Time format** if you want to change current time format. 24-hour and 12-hour time formats are available.
 - **Date format** if you want to change current date format.
 - **Set time & date** if you want to change current time and date. Use navigation keys.
- 3) Press **Select** or **OK** to save the setting.



Answering

This section describes how to change the answering behaviors on your handset.

Answering Key

The default setting for the handset is to use the **Call key**  when answering a call.

- 1) In the **Settings** menu, select **Answering > Answering key**.
- 2) Select **Call key** or **Any key**.

NOTICE: If **Any key** is selected, any key except the **End call key** , the **Sound off key** **Sound off key**  **#** , and Mute/PTT button can be used to answer the call.

Answering Behavior

- 1) In the **Settings** menu, select **Answering > Answering behavior**.
- 2) Select one or several of the following options:
 - **Automatically** if you want the call to be answered automatically.
 - **Loudspeaking** if you want the call to be answered in loudspeaking mode.
 - **Quick answer** if you want the call to be answered automatically when the handset is removed from the charger.
- 3) Press **Change** to change the setting. The check box is marked. To remove the selection, press **Change** again.

Change Text Size for Messages

NOTICE: Applicable to WL4 Messaging and WL4 Plus only.

- 1) In the **Settings** menu, select **Messages > Text size**.
- 2) Select **Normal** or **Large**.
- 3) Press **Back**.

Change the Menu Language

- 1) In the **Settings** menu, select **Language**.
- 2) Select a language from the list.

Change Owner ID

An Owner ID can be set to identify the handset.

- 1) In the **Settings** menu, select **Owner ID**.
- 2) Enter identity. See [Alphanumeric Keys](#) on page 14.
- 3) Press **Save**.

Alarm Settings

It is recommended to configure a shortcut to this menu if it is frequently used, see [Shortcuts](#) on page 48.

NOTICE: Applicable to WL4 Plus only.

Enable Man-down and No-movement Alarms

- 1) In the **Settings** menu, select **Alarm > Activate alarm**.
- 2) Select the required alarm(s). The corresponding icons appear on the display.

Follow the same steps to disable the alarms.

Edit Alarm Data

Data can be added to all types of alarms at transmission Information. It is recommended to create a shortcut for quick access to the **Edit alarm data** menu, refer to the [Shortcuts](#) on page 48.

- 1) In the **Settings** menu, select **Alarm**.
- 2) Select **Edit alarm data**.
- 3) Enter alarm data.
- 4) Press **Save**.

Administrator Menu

The handset has a hidden menu for system administrators. refer to the Configuration Manual, Unify OpenScape WLAN Phone WL4.

Profiles

There are two types of profiles that can be configured for the handset:

- User profiles, refer to the [User Profiles](#) on page 56.
- System profiles, refer to the [System Profiles](#) on page 57.

User Profiles

An own profile is configured directly on the handset in the **Profiles** menu and can be set up for incoming calls, message alerts, message volume, vibrating alerts, key sound, and so on. This can be useful when there are many users on the same handset who require different sound profiles. It can also be used for temporarily settings, for example when incoming calls should be silent in a meeting. A user can then switch to his or her own particular profile when using the handset.

If no profile is selected, the normal settings are used.

NOTICE: The settings in a user profile can be superseded if the corresponding settings are enabled in a system profile. When the system profile is enabled, its settings are not displayed in the handset menu. For the details, refer to the [System Profiles](#) on page 57.



To open the **Profiles** menu  , do the following:

- 1) In Idle mode, press **Menu** or the middle navigation key.
- 2) Select **Profiles** and press the middle navigation key or the **Select** soft key to enter.



To get the detailed information about the whole **Profiles** menu structure, refer to the [Profiles](#) on page 80.

Add New User Profile

- 1) In the opened **Profiles** menu, select **Add new**.
- 2) Enter a name for the profile.
- 3) Press **Save**.
- 4) If needed, select the setting and Press **Edit** to make changes.
- 5) Press **Back** to save changes.

Activate Profile

- 1) In the **Profiles** menu, select a profile from the list.
- 2) Press **Select**.

When a profile is activated, the **Profiles** icon   and the name of the profile are displayed in Idle mode.

Delete Profile

- 1) In the opened **Profiles** menu, select a profile from the list.
- 2) Press **More > Delete**.
- 3) Press **Yes** to confirm.

Edit Profile

- 1) In the opened **Profiles** menu, select a profile from the list.
- 2) Press **More > Edit**.
- 3) Select the setting to be changed and press **Edit**.
- 4) Press **Back** to save changes.

System Profiles

NOTICE: Applicable to OpenScope WL4 Plus only.

A system profile can be used when certain settings are required to be set on a handset but are not allowed to be changed by the user. When the system profile is activated, the settings are not displayed in the handset's menu. The system profile name is displayed when the handset is in Idle mode. For more information, refer to the Configuration Manual, Unify OpenScope WLAN Phone WL4.

The system profile can be used in combination with the user profile, refer to the [Profiles](#) on page 56. If there is a conflict between the settings in the system profile and the settings in the user profile, the settings in the system profile are used.

If a user changes a setting in the handset menu that is determined by a system profile, the changes will be not applied.

For example, the [Figure 8: System Profile Overrides Settings Changed by the User](#) on page 57 shows that a system profile has been activated under the name `Sys Profile SK1`. In this case, **Inbox** and **PTT 4** soft key functions are determined by the system profile settings. If a user attempts to change, for example, the name of these functions using the handset menu, the changes will not be applied. Changes will be applied only in case if the system profile is deactivated.

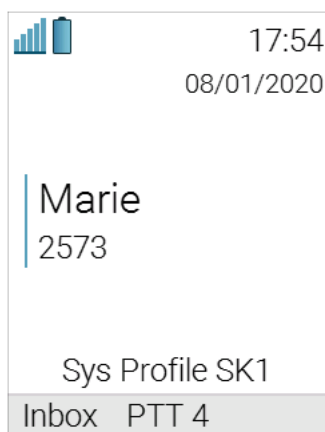

Figure 8: System Profile Overrides Settings Changed by the User

System Profile Status Indications

The system administrator can configure the handset to play a sound if the system profile is activated or deactivated. This provides the user with an audible alert when the system profile changes from inactive to active or vice versa.



The feature can be triggered by several kinds of events, such as moving between different parts of a buildings where a system profile might be appropriate in one location but not required in another. The user should be aware that the characteristics and behavior of the handset change when the system profile changes.

Contacts

The handset has a phonebook with 250 entries where names and numbers can be added, deleted, and edited. The phonebook lists all names in alphabetical order, where three numbers can be added for each contact: a work number, a mobile number, and another number.

A company phonebook with up to 1000 entries can also be downloaded to the handset via the WinPDM/WSG DM. The company phonebook name and numbers can not be edited or deleted by the user. The phonebook lists all names in alphabetical order. The local and company phonebook appears in the same list but the company names are indicated by an icon  in front of the name. Refer to the [Call Using the Company Phonebook](#) on page 22 for more information.

A central phonebook can also be accessed, refer to the [Call Using the Central Phonebook](#) on page 22. This feature is a system dependent feature.

NOTICE: When searching for a contact, adding and editing a contact, the input language can be changed temporarily by long pressing the **Lock** key   . This can be used to temporarily access characters in a foreign language.

To open the **Contacts** menu  , do the following:

- 1) In Idle mode, press **Menu** or the middle navigation key.
- 2) Select **Contacts** and press the middle navigation key or the **Select** soft key to enter.

To get the detailed information about the whole **Contacts** menu structure, refer to the [Contacts](#) on page 81.

Call Contact

- 1) In the **Contacts** menu, select **Call contact**.
- 2) Select a contact from the list or enter a name/ number in the search field.
- 3) Press the **Call** key  or the **Call** soft key to make a call.

The contact can be edited, a message can be sent, and the number can be deleted by selecting **View > More**.

Add New Contact

- 1) In the **Contacts** menu, select **Add contact > New**.
- 2) Enter the name of the contact.
- 3) Press **OK**.
- 4) Select **Work number**, **Mobile number**, or **Other number**.
- 5) Press **Add**.
- 6) Enter handset numbers.
- 7) Press **OK > Save**.

Add From Call List

- 1) In the **Contacts** menu, select **Add contact > From call list**.
- 2) Select number.
- 3) Press **Add**.
- 4) Select number type.
- 5) Press **Select > Add**, and enter the name of the contact.

- 6) Press **OK > Save**.

Edit Contact

- 1) In the **Contacts** menu, select **Edit contact**.
- 2) Select contact and press **Edit**.
- 3) Enter a new name or number, or both.
- 4) Press **OK > Save**.

Set Ring Signal for a Contact

A specific ring signal can be set for each contact.

- 1) Add or edit a contact according to [Add New Contact](#) on page 58 or [Edit Contact](#) on page 59.
- 2) Select **Ring signal**.
- 3) Select the ring signal to be used for the selected contact.
- 4) Press **Back > Save**.

Delete Contact

- 1) In the **Contacts** menu, select **Delete contact**.
- 2) Select contact and press **Delete**.
- 3) Press **Yes** to confirm.

Central Phonebook

In the **Central phonebook** contacts can be searched by name or number.

When the search result is returned, the contact information can be viewed. A number can be assigned to the new contact and a message can be sent by pressing the **More** soft key. The number can also be called by pressing the **Call** soft key or the **Call** key .

For the details, on how to use the **Central phonebook**, please refer to the [Call Using the Central Phonebook](#) on page 22.

System Handling

To view the handset's software version, enter *#34# in Idle mode.

Software and parameters in the handset can be upgraded using the following tools:

- The DP1 Desktop Programmer connected to the WinPDM, refer to the Installation and Operation Manual, Portable Device Manager for Windows (WinPDM).
- The WSG Device Manager, refer to the User Manual, Device Manager, TD EN. Installation and Operation Manual, OpenStage Wireless Service Gateway (WSG).

For additional information on software and parameters upgrade, refer to the Configuration Manual, Unify OpenScape WLAN Phone WL4.

Device Information

In the **Device Info** menu, you can view information about the handset, which can be useful when contacting the system administrator to get support:

- Software version
- Hardware version
- License
- WLAN info
- Network info
- User ID

To open the **Device info** menu on the handset, do one of the following:

- Go into the **Main menu** > **Settings** > **Device info**.
- Enter the **Admin menu** (refer to the [Administrator Menu](#) on page 55) and select **Device info**.
- In idle mode, press the keys *#DI#, that is *#34# (DI as in Device Information).

Software Upgrade and Additional Features

Software and parameters in the handset can be changed by using the WinPDM/WSG DM. Refer to the Installation and Operation Manual, Portable Device Manager for Windows (WinPDM) or the Installation and Operation Manual, OpenStage Wireless Service Gateway (WSG).

Examples of additional features that can be downloaded/configured via WinPDM/WSG DM:

- Company phonebook
- Customizing the menu tree
- Certificates

Operation Notice

Accessibility and Voice Quality

The handset can only be used in the area covered by the system. Outside of this area the handset loses contact with the system. The signal strength icon is empty and `No network` is displayed.

When you leave the area that is covered by the system, the handset will notify you about that with a short beep signal and the `No network` text in Idle mode. To turn off the beep indication, press and hold the **Sound off** key `#` `M` or the Mute button.

The indication is by default repeated every minute for 30 minutes.

NOTICE: This is a default and recommended for use indication setting. The vibrating alert and the dialog window (pop-up) can be additionally enabled, while the signal sound can be disabled. Indication frequency can also be changed to indicate only once or can be turned off completely. For the details, please refer to the Configuration Manual, Unify OpenScape WLAN Phone WL4.

When re-entering the coverage area it can take a couple of minutes before the handset is automatically registered with the system.

The WLAN network is not always available, but if you continue experiencing network problems, contact your system administrator as soon as possible.

Maintenance

This chapter describes how to maintain handsets, with a focus on battery replacement and charging, as well as it gives recommendations on how to keep the handset charged longer.



Maintenance of Batteries

Low Battery Indication

If the battery level is low, charge the battery or change it to a fully charged one as soon as possible.

The warning signal cannot be silenced during a call. When not in a call, the warning signal can be silenced by pressing and holding the **Sound off** key **#** **ⓧ** or the mute button.

NOTICE: The warning signal when the battery is low can be set to one of the three different modes: **Sound repeatedly**, **Sound once**, or **Sound off**. For the details, refer to the Configuration Manual, Unify OpenScape WLAN Phone WL4.

	<p>The Low battery icon is displayed when the battery has 25 to 10% remaining capacity.</p> <p>A low battery level is also indicated by a warning signal that sounds every minute and the <code>Battery low. Charge now.</code> notification.</p>
	<p>The Very low battery icon is displayed when the battery has 10 to 7% remaining capacity.</p> <p>A very low battery level is also indicated by a warning signal that sounds every minute and the <code>Battery very low. Charge now.</code> notification.</p>
	<p>The Empty battery icon is flashing when the battery has 7% or less remaining capacity.</p> <p>An empty battery also indicated by a warning signal that sounds every second and the <code>Battery empty. Shutting down.</code> notification.</p>

Charging Methods

The handset has a rechargeable battery that can be charged separately from the handset. To charge it, use the Battery pack charger. If you want to charge the handset together with battery, do it either with a Desktop charger or using a Charging rack.

NOTICE: Use manufacturer-provided chargers only.

Charge the Handset

- 1) Place the handset in the Desktop charger or in a Charging rack. Push the handset into the charger to fully insert it. If the handset is correctly inserted, the charging screen (screen saver) appears showing the owner ID, current time and the white battery icon indicating the ongoing charging.
- 2) When the green battery icon appears on the screen, the battery is fully charged.
- 3) To remove the handset from the charger, tilt the handset towards you and lift it upwards.

NOTICE: It is not recommended to lift the handset upwards before tilting it towards you.

Charge the Battery

- 1) Follow the steps 1–3 described in [Replace the Battery](#) on page 63.
- 2) Place the battery in the charging slot. Slide the battery lock to the left. If the battery has been correctly inserted, the LED indicator on the battery charger turns red to show that the battery is charging.
- 3) The battery is fully charged when the LED indicator turns green.

Replace the Battery

The battery of the handset is exchanged easily. This is useful when there is limited time for charging, or if additional battery time is needed. If the battery capacity and performance drops significantly, replace it with a new one. Please contact the system administrator or handset supplier for a new battery.

To replace the battery follow the instruction below:

- 1) Switch off the handset to prevent data loss or damage to the handset.
- 2) Slide the battery cover lock to the right to release the battery.
- 3) While pressing and holding the upper part of the clip, remove the battery from the handset the way it is shown in [Figure 9: Replace the Battery](#) on page 63.
- 4) Insert a fully charged/ new battery while pressing and holding the upper part of the clip.
- 5) Slide the battery cover lock to the left to lock it. The handset starts automatically after the battery is inserted.

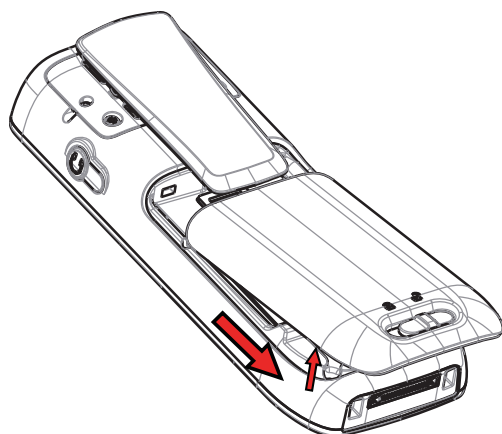

Figure 9: Replace the Battery

Energy Efficiency

Recommendations on how to save energy and battery lifetime:

- Do not charge a battery when the ambient room temperature is above 45°C or below 0°C (above 113°F or below 32°F). Charging below 0°C harms the battery and shortens the lifetime.
- Note that storing Li-Polymer batteries at high temperature dramatically reduces its capacity. For example storage around maximum temperature reduces capacity with 20% in less than a month, permanently.



- When extended battery lifetime is needed, set the handset screen saver to the **Black also in call** option. Refer to the [Display Settings](#) on page 53 section.
- The handset can be configured to switch off when placed in the charger. When removed from the charger, the handset switches on automatically. For more information, refer to the [In Charger Action](#) on page 47.
- If the charger is not used for a longer period of time, remove the power adapter to the charger.
- Do not put the handset in charger if no charging is needed.

Troubleshooting

This chapter contains information on how to solve common operational problems and is mainly targeted towards the handset end users. If this checklist does not solve the existing problem, it is recommended to contact the system administrator for support.

NOTICE: If others users have similar problems, there may be a system error.

Table 3: Operational problems

Fault	Probable cause	Action or comment
Not possible to switch off the handset.	The handset is most likely configured to restrict the user from switching the handset off.	Contact the system administrator for support. Ask to turn off the Block switch off parameter to have no further restrictions.
Cannot use the handset. The dialog window appears saying that the handset is locked	Phone lock is activated.	<ul style="list-style-type: none"> – Enter the required PIN code. – If the PIN code has been lost, contact the system administrator for support.
No entries in the Call list.	The handset is most likely configured to prevent calls from being saved in the Call list.	Contact the system administrator for support. Ask to turn on the Call list parameter to store outgoing and incoming calls.
The display stays dark.	The battery level is empty.	Charge or replace the battery.
	Power save mode is enabled.	Change the brightness on the handset by going into the Settings menu → Display > Brightness . Select Normal .
There is no ring signal.	The handset is muted.	<p>The Silent off icon  in the status bar shows that the handset is muted.</p> <p>In idle mode, press and hold the Sound off key #  or the mute button to unmute the handset.</p>

	Ring volume set to silent.	The Silent volume icon  in the status bar shows that the volume is set to silent. Increase the volume by pressing the Volume up button or by going on the handset into the Settings > Sound & Alerts > Volume .
Not possible to mute the handset or set the ring volume to "Silent".	The handset is most likely configured to restrict the user from muting or setting the volume to silent.	Contact the system administrator for support. Ask to turn off the Prevent silent parameter to have no sound restrictions.
One of the following messages appeared on the screen: <ul style="list-style-type: none">• Remotely updated• Updating handset...• Handset is updated	New software has been installed or some parameters have been remotely changed on the handset	No action needed. Wait for the handset to restart or start up.
Wrong time & date setting.	PBX dependent. The handset hasn't received the right time and date after a change in the system	– Switch the handset off and on again. – Wait maximum 24 hours for the changes to appear. – If still wrong, contact the system administrator for support.
No channel available	The handset did not receive the expected answer from the PBX during call setup, or the user attempts to make a call when the handset is displaying <i>Messaging only</i> .	Make another call (when the handset is not showing <i>Messaging only</i>). If the handset does not work after another try, contact the system administrator.

Error or Warning Messages

Error or warning messages appear directly on the handset's display and contain a short information about current technical problems. In such cases, you can see one of the following texts:

- No network
- No access
- No channel available

- Voice only
- Messaging only
- Limited mode
- SERVICE NEEDED

If you continue experiencing technical problems, contact your system administrator as soon as possible.

For system administrators, it is recommended to refer to the Configuration Manual, Unify OpenScape WLAN Phone WL4 to get the details as well as guidance on further actions to resolve the existing problems.

Related Documents

Data Sheet, Unify OpenScape WLAN Phone WL4

Configuration Manual, Unify OpenScape WLAN Phone WL4

System Planning, VoWiFi System, TD 93358EN

Quick Reference Guide, Unify OpenScape WLAN Phone WL4

Installation and Operation Manual, Portable Device Manager for Windows (WinPDM)

Installation and Operation Manual, OpenStage Wireless Service Gateway (WSG)

Safety and Regulatory Instructions

For safe and efficient operation of the handset, observe the guidelines given in this manual and all necessary safety precautions when using the handset. Follow the operating instructions and adhere to all warnings and safety precautions located on the product, the Safety Information delivered with the handset and this User Manual.

Precautions

- Avoid volume levels that may be harmful to your hearing. Exposure to excessive sound pressure from a handset's earpiece or headset may cause permanent hearing loss.
- Do not use auxiliary equipment with the handset which is not exclusively recommended by the manufacturer. The use of any auxiliary equipment not recommended by the manufacturer may result in fire, electric shock, or injury, and will void the warranty.

FCC and ISED Compliance Statements

This equipment has been tested and found to comply with the limits for a Class B digital device, pursuant to part 15 of the FCC Rules. These limits are designed to provide reasonable protection against harmful interference in a residential installation. This equipment generates, uses and can radiate radio frequency energy and, if not installed and used in accordance with the instructions, may cause harmful interference to radio communications. However, there is no guarantee that interference will not occur in a particular installation.

If this equipment does cause harmful interference to radio or television reception, which can be determined by turning the equipment off and on, the user is encouraged to try to correct the interference by one or more of the following measures:

- Reorient or relocate the receiving antenna
- Increase the separation between the equipment and receiver
- Connect the equipment into an outlet on a circuit different from that to which the receiver is connected
- Consult the dealer or an experienced radio/TV technician for help

CAN ICES-3 (B)/NMB-3(B)

Privacy of communications may not be ensured when using this handset.

Exposure to Radio Frequency Signals

This equipment complies with FCC radiation exposure limits set forth for an uncontrolled environment. This device complies with FCC SAR limit of 1.6 W/kg.

For SAR values, see the Data Sheet, Unify OpenScape WLAN Phone WL4.

This device must not be co-located or operating in conjunction with any other antenna or transmitter.

Use of non-Ascom approved accessories may violate the FCC and ISED guidelines for RF exposure and should be avoided.

Information to User

This device complies with Part 15 of the FCC rules and with ISED license-exempt RSS standards.

Operation is subject to the following two conditions:

- 1) this device may not cause harmful interference, and

- 2) this device must accept any interference received, including interference that may cause undesired operation.

Le présent appareil est conforme aux règles FCC partie 15 et aux CNR d'Industrie Canada applicables aux appareils radio exempts de licence.

L'exploitation est autorisée aux deux conditions suivantes:

- 1) l'appareil ne doit pas produire de brouillage, et
- 2) l'utilisateur de l'appareil doit accepter tout brouillage radioélectrique subi, même si le brouillage est susceptible d'en compromettre le fonctionnement.

Environmental Requirements

This section includes information about environmental requirements to be followed.

WLAN Phone

- Only use the handset in temperatures between -5°C and $+45^{\circ}\text{C}$ (23°F and 113°F).
- If the handset has been exposed for water or condense, remove the battery immediately and let it dry completely before re-inserting the battery.
- Keep the handset away from strong electromagnetic fields.

Battery

- Do not immerse the battery into water. This could short-circuit and damage the battery.
- Do not expose a battery to an open flame. This could cause the battery to explode.
- Do not allow the metal contacts on the battery to touch another metal object. This could short-circuit and damage the battery.
- Do not leave a battery where it could be subjected to extremely high temperatures, such as inside a car on a hot day.
- Use the Desktop Charger or the wall-mounted Charging Rack for charging. Charge the battery for at least one hour the first time you use the battery. Note that the wall-mounted Battery Pack Charger has to be used if the battery alone is to be charged.
- Do not charge a battery when the ambient room temperature is above 45°C or below 0°C (above 113°F or below 32°F). Charging below 0°C will harm the battery and shorten the life-time.
- Do not attempt to take a battery apart.

Battery Disposal

Defective batteries must be returned to a collection point for chemical waste disposal.

Chemical Resistance

The alphanumeric characters printed on the handset have been tested and found resistant to chipping, fading, or wearing off when the handset is treated with common cleaning products, disinfectants, or it is exposed to perspiration. Acetone can damage the plastic case of the handset and should not be used.

The following chemicals have shown no harmful effects:

- 3% Hydrochloric Acid
- M-alcohol (70% Methylated Ethanol)
- 60% Chlorhexidine 0.5 mg/ml

Functions and Accessories

Table 4: Functions

	WL4	OpenScape WL4 Messaging	OpenScape WL4 Plus
Multiple language support (20 languages)	+	+	+
Local phonebook (250 contacts)	+	+	+
Central phonebook ²⁷ , ²⁸	+	+	+
Company phonebook (1,000 contacts)	+	+	+
Personal alarm	–	–	+
Man-down and No-movement alarm ²⁷	–	–	+
Automatic call after alarm	–	–	+
Acoustic Location Signal (ALS)	–	–	+
Alarm on outgoing emergency call (for example 911/912) ²⁷	–	–	+
Alarm with data ²⁷	–	–	+
Alarm with location ²⁷	–	–	+
Messaging ²⁷	–	+	+
Interactive Messaging ²⁷	–	+	+
Colored messaging ²⁷	–	+	+
Message acknowledgement ²⁷	–	+	+
Voicemail	+	+	+
Push-to-talk (PTT) ²⁷	–	–	+
Five configured emergency numbers	+	+	+
Send data ²⁷	–	–	+
User profiles	+	+	+
System profiles	–	–	+
Shared phone ²⁷	+	+	+
Administrator menu	+	+	+

²⁷ This function is configured by the administrator.

²⁸ This function is system dependent.

	WL4	OpenScape WL4 Messaging	OpenScape WL4 Plus
Programmable in charger behavior	+	+	+
Multifunction button	+	+	–
Programmable keys	+	+	+
Manual and automatic keypad lock	+	+	+
Phone lock	+	+	+
Custom sounds	+	+	+
Services	–	–	+
BLE location	–	–	+
AiRISTA Flow RTLS	–	–	+
Cisco MSE	–	–	+
Bluetooth	+	+	+

Table 5: Accessories

Desktop charger
Charging rack
Battery pack
Battery pack charger
Desktop programmer
Carrying case
Standard clip
Swivel clip
Security string
Silicon cover

Menu Tree

This chapter gives the detailed information about the whole **Main menu** structure and includes the following:

- [Messaging](#) on page 73
- [Connections](#) on page 74
- [Calls](#) on page 75
- [Shortcuts](#) on page 76
- [Services](#) on page 77
- [Settings](#) on page 77
- [Profiles](#) on page 80
- [Contacts](#) on page 81
- [In Call](#) on page 82

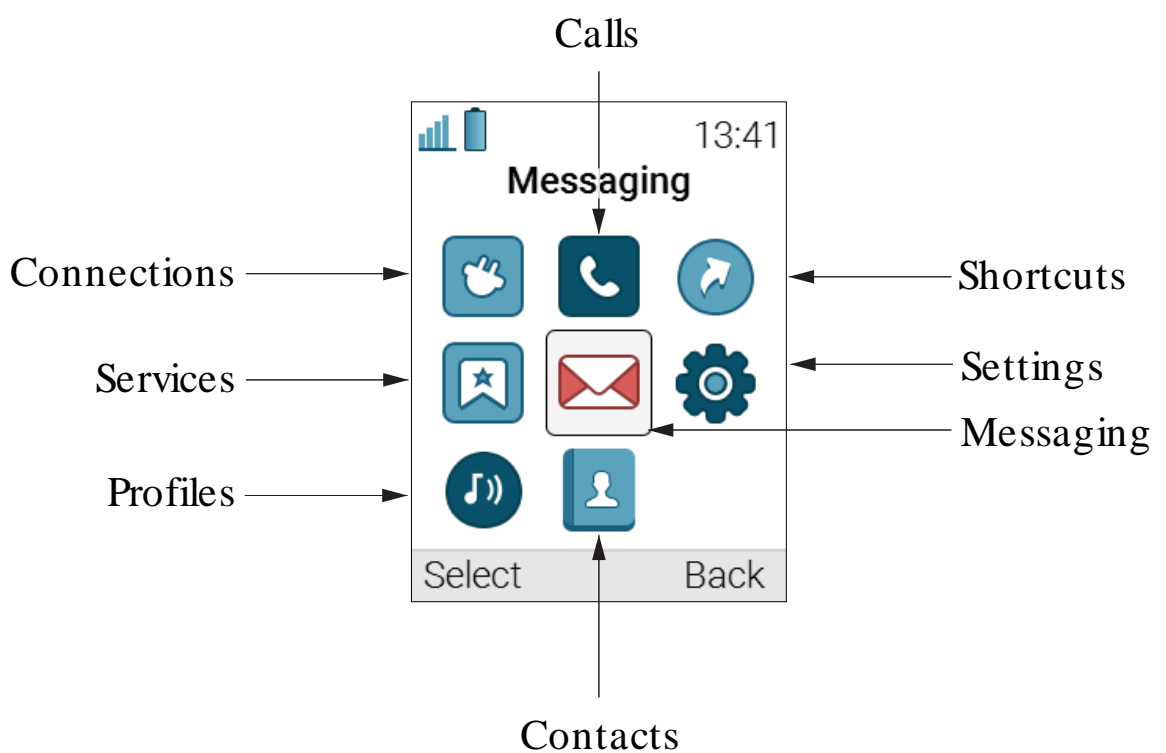

Figure 10: The Main menu screen

Customize the Menu Tree

The menu tree can be customized by hiding some of the functions or making them read-only. The functions that should be hidden are defined in the WinPDM/WSG DM. For more information, refer to the Configuration Manual, Unify OpenScape WLAN Phone WL4.

Messaging

NOTICE: Applicable to WL4 Messaging and WL4 Plus only.



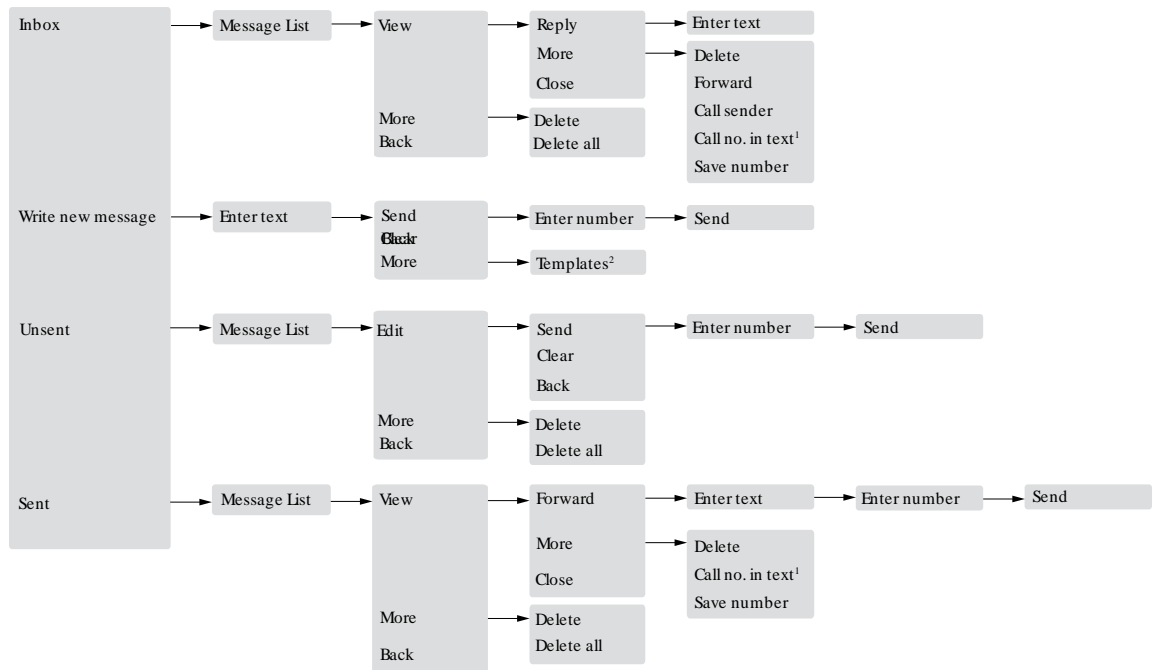

1. Visible only if the number used in the body text message consists of minimum three digits.
2. Visible only if there exist at least one template.

Connections



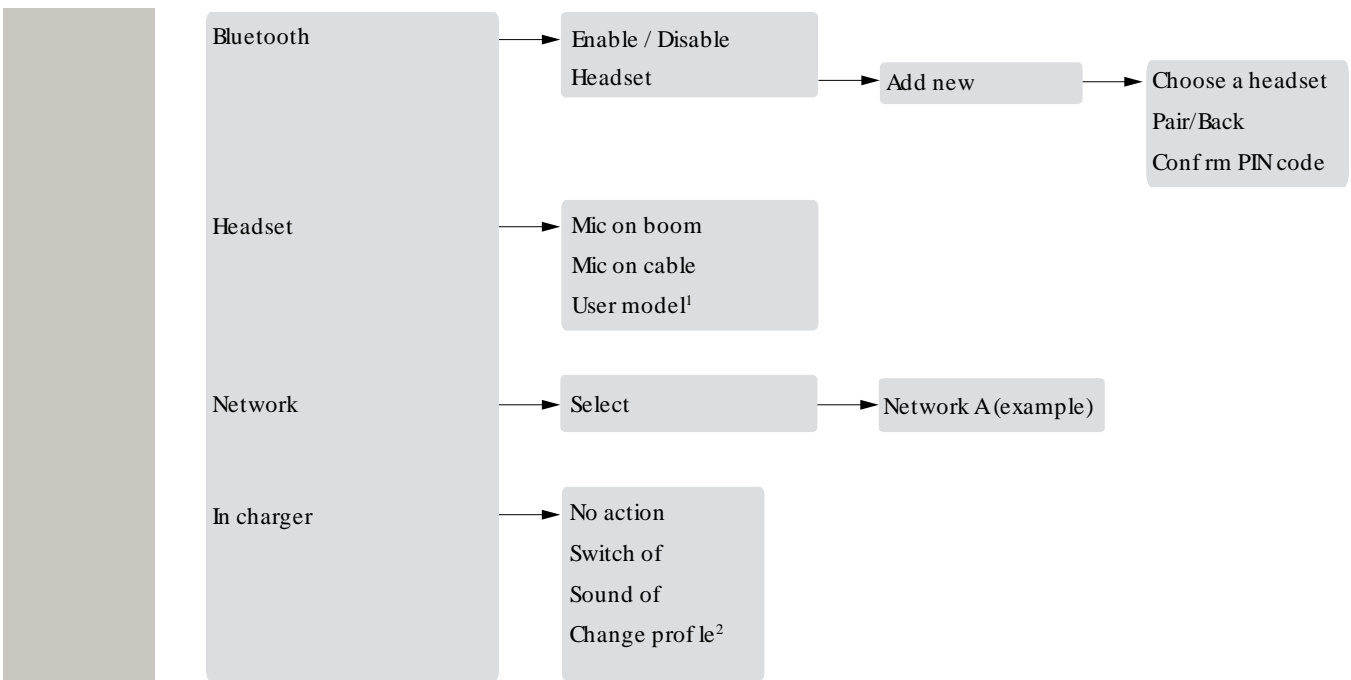

- 1. This function is configured by the system administrator.
- 2. Applicable to WL4 Plus only.

Calls



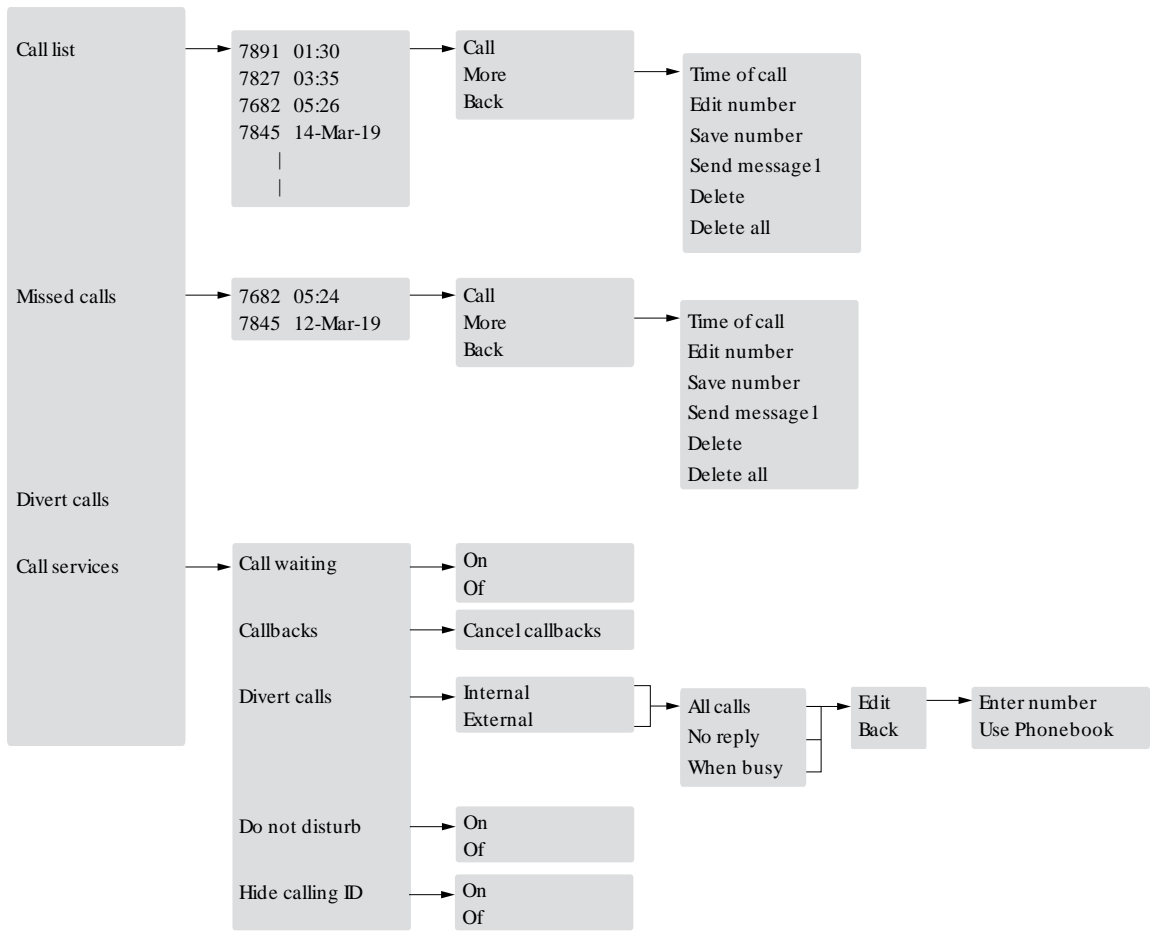

1. Applicable to WL4 Messaging and WL4 Plus only.

Shortcuts



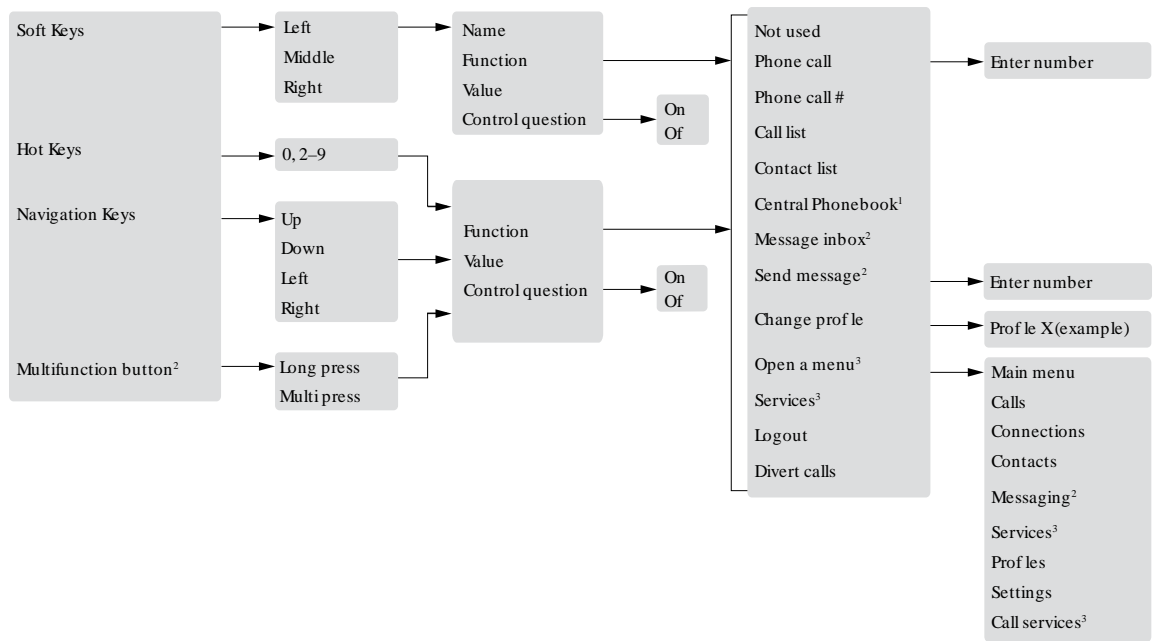

1. This function is system dependent.
 2. Applicable to WL4 Messaging and WL4 Plus only.
 3. Applicable to WL4 Plus only.

Services

NOTICE: Applicable to WL4 Plus only.

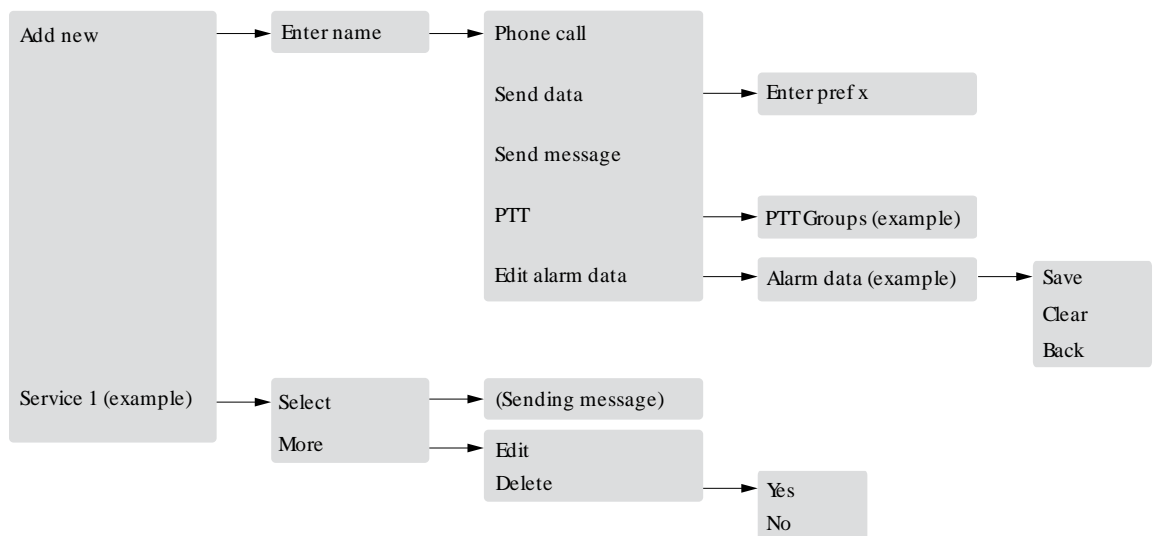

Settings



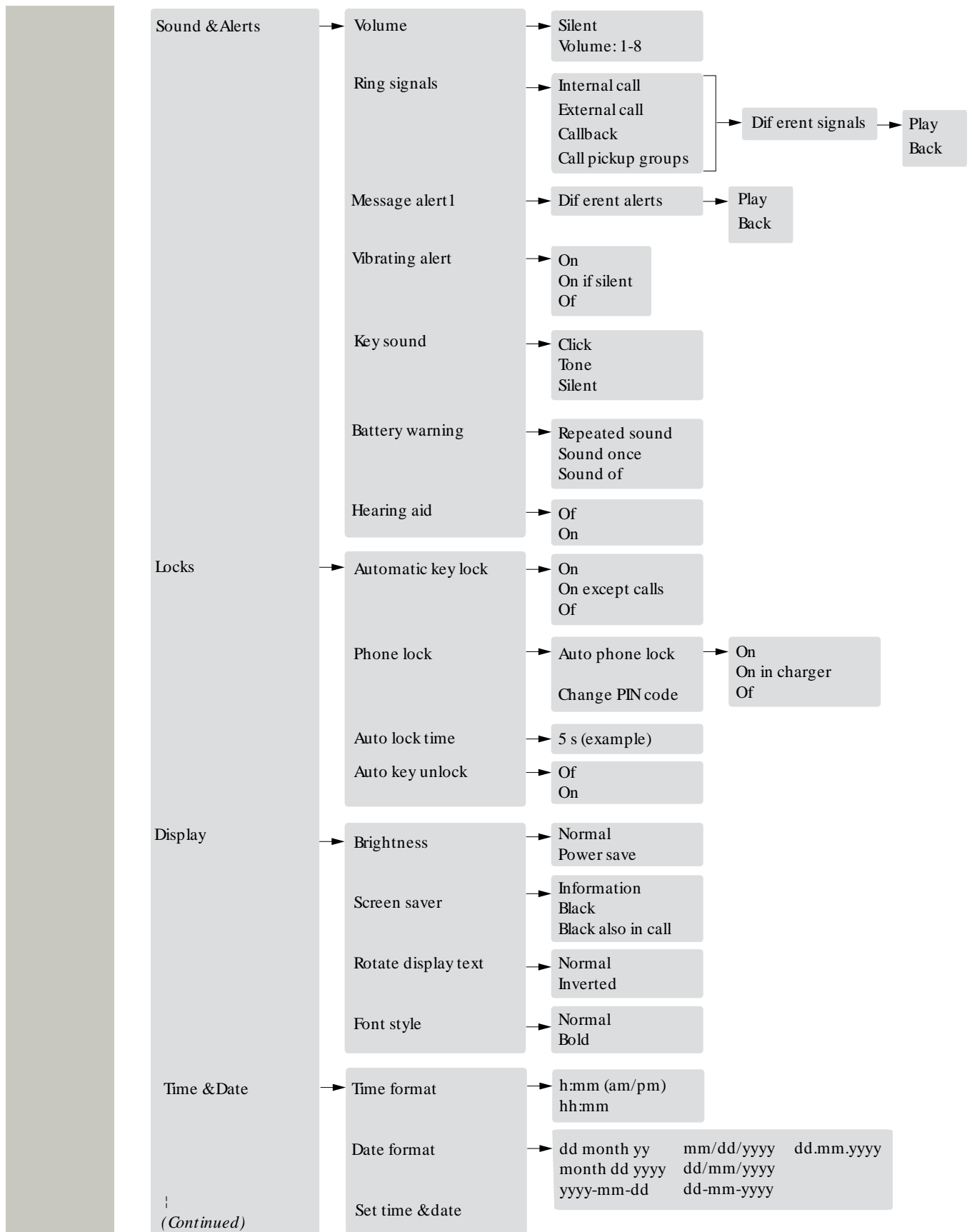

1. Applicable to WL4 Messaging and WL4 Plus.

Settings (Continued)

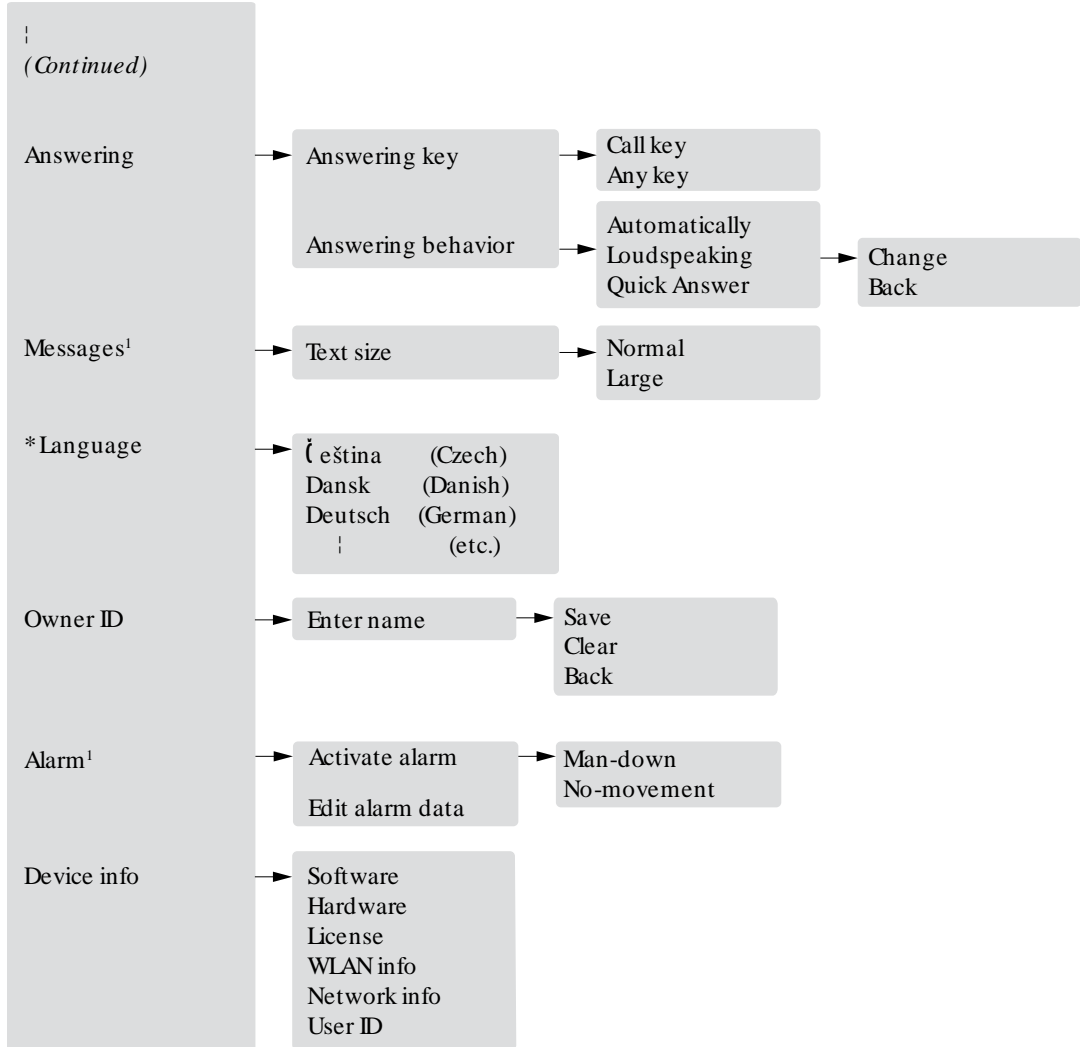

1. Applicable to WL4 Messaging and WL4 Plus only.
2. Applicable to WL4 Plus only.

Profiles



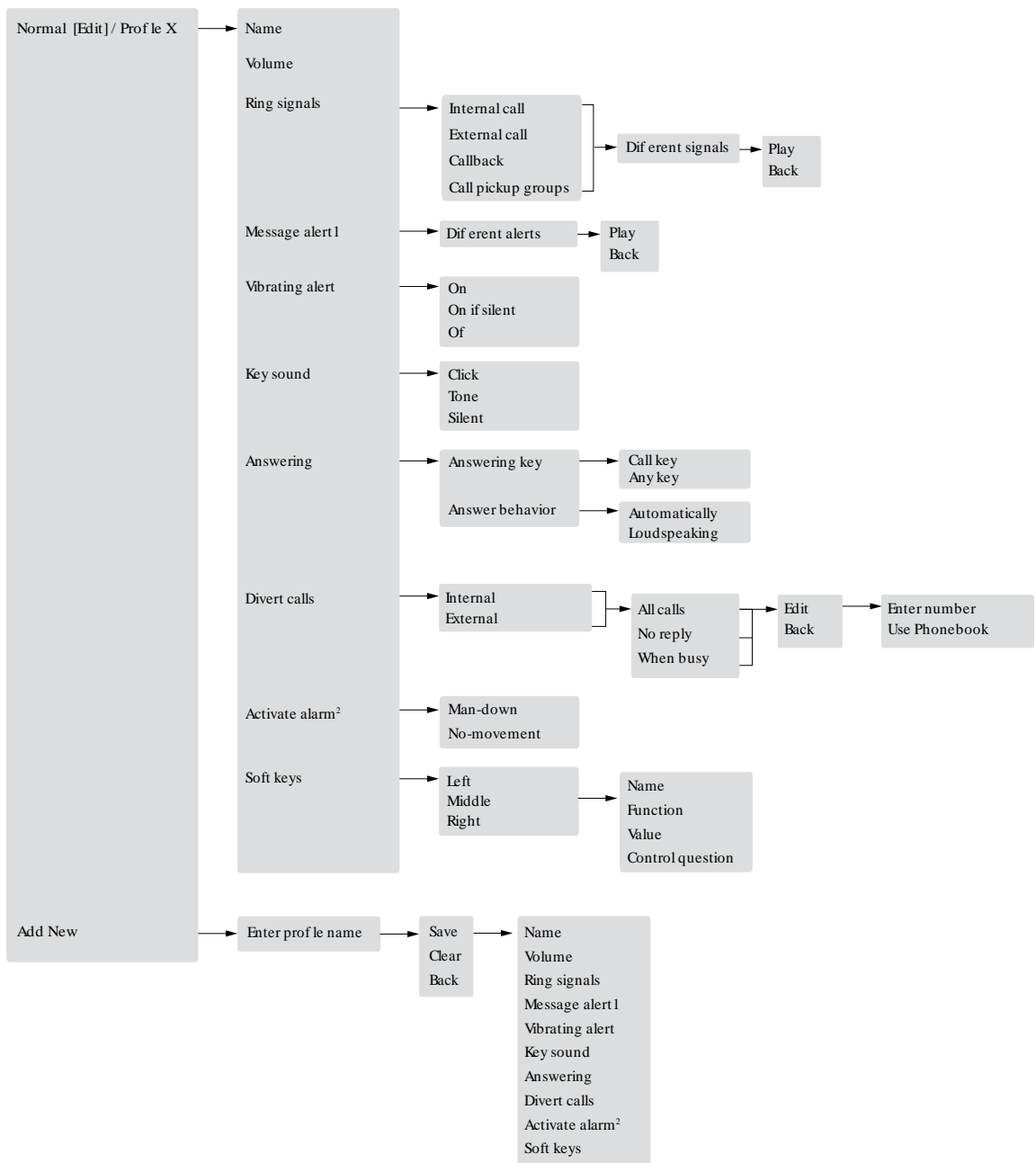

1. Applicable to WL4 Messaging and WL4 Plus.
2. Applicable to WL4 Plus only.

Contacts



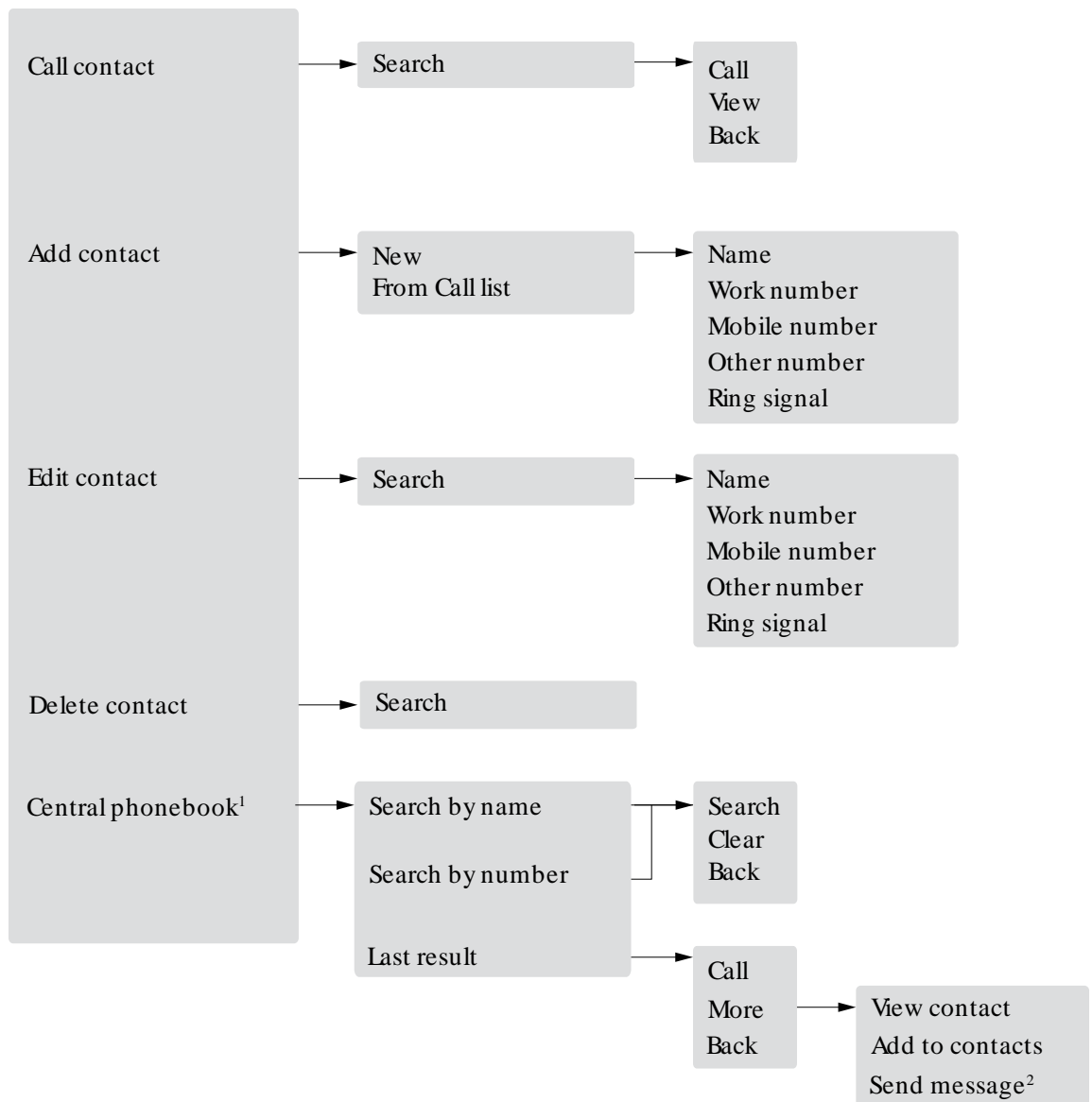

1. This function is system-dependent.
2. Applicable to WL4 Messaging and WL4 Plus only.

In Call

The **In Call** menu displays a list of functions that can be accessed during a call. To refer to the available functions, press **More**. Some functions are always provided and others may be made available by the administrator via the WinPDM/WSG DM. To use a function, navigate the **In Call** menu to highlight the required function and then press the **Select** soft key.

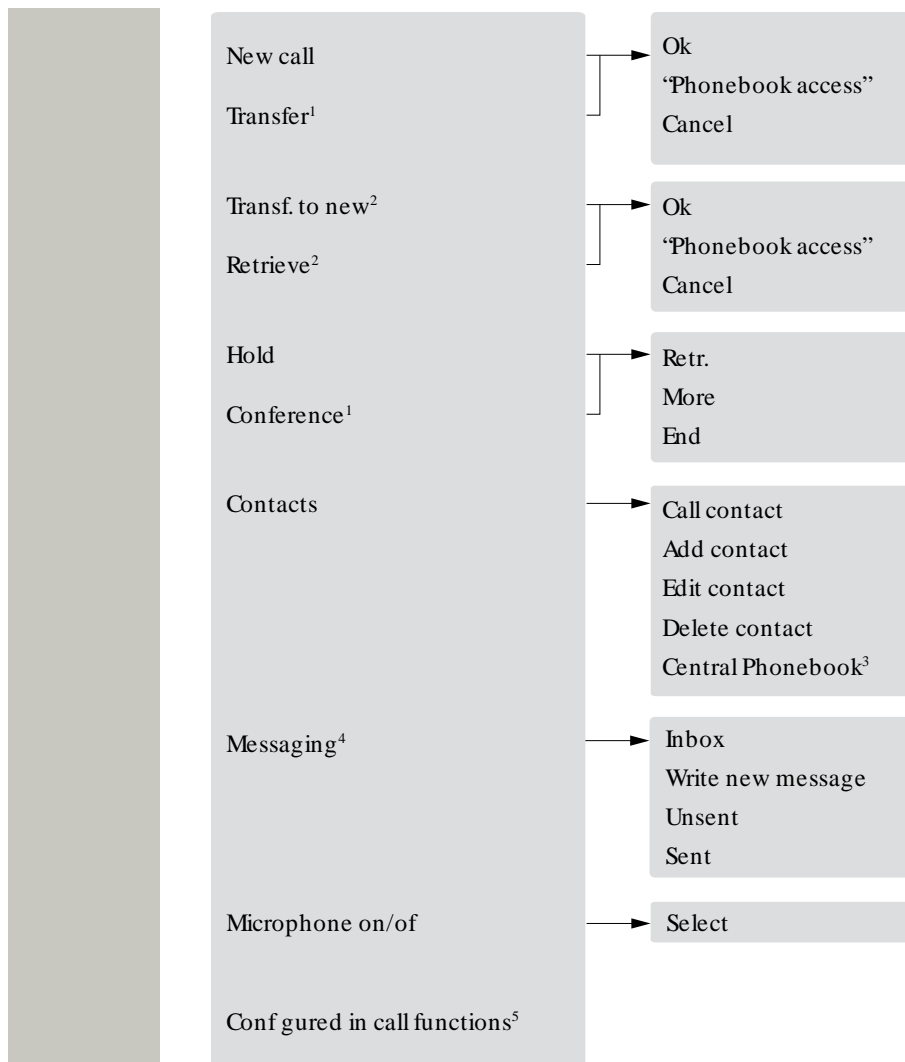

1. Visible only for certain call situations.
2. Can appear on left soft key or on More menu, depending on the current call status.
3. This function is system dependent.
4. Applicable to WL4 Messaging and WL4 Plus only.
5. Visible only if conf gured in WinPDM/WSG DM.